

Maneuvering the Assembly Documentation

1. Select your bookmark of interest
2. Click on the (+) to expand your selection and select the submenu

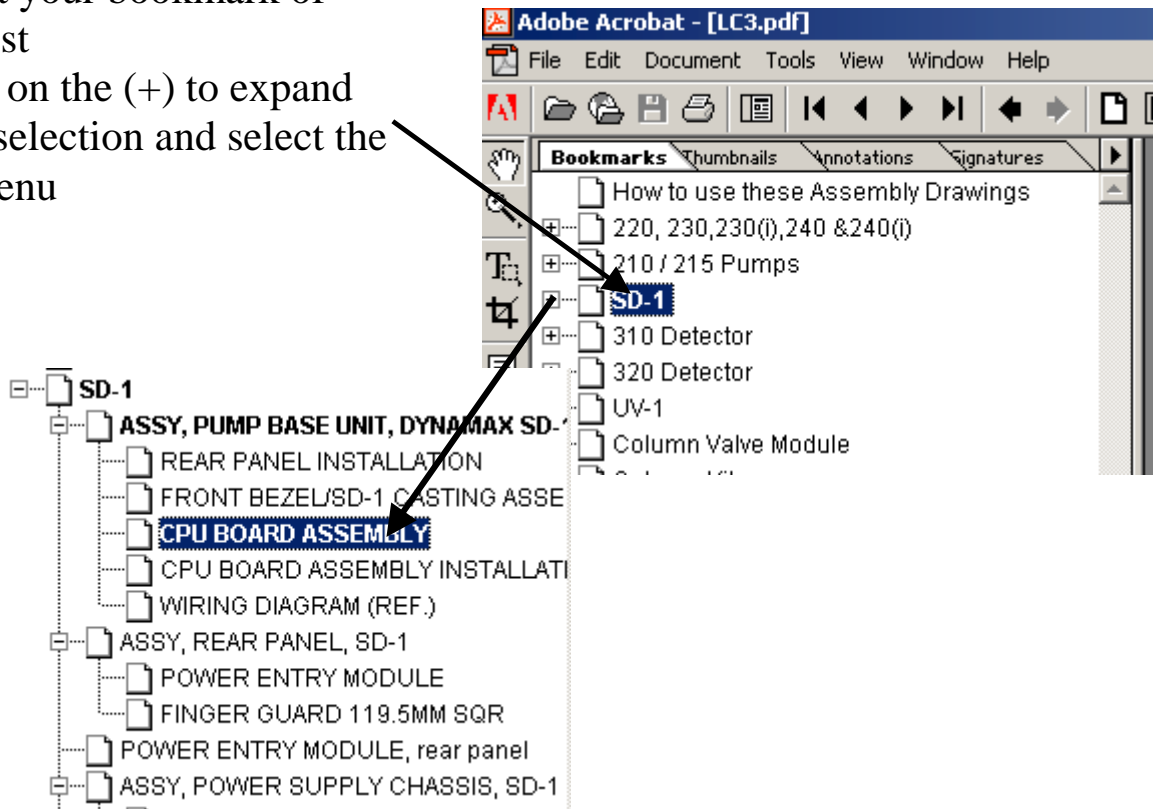

3. Navigate through the document with these buttons

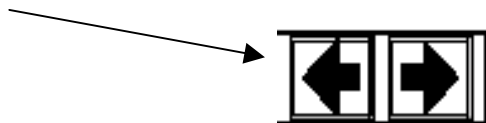

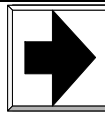
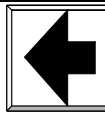
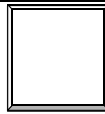

ASSY, BASIC ELECTRICAL, (120V SHOWN)
3900GC GALILEO STATION #1, ASSEMBLY PROCEDURES



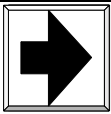
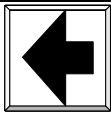

12-222008-12, 4 PLCS SCREW, 8-32 X 3/4, PAN

03-925315-02, 3 PLCS PLASTIC, FOOT

12-901163-00, 2 PLCS SCREW, 8-32 X 3/8, SEM

R0-028000-84 FOOT, MOUNTING

R0-028120-23 WASHER, #10, FLAT

03-933207-01 SPACER, SOFT CHASSIS FOOT

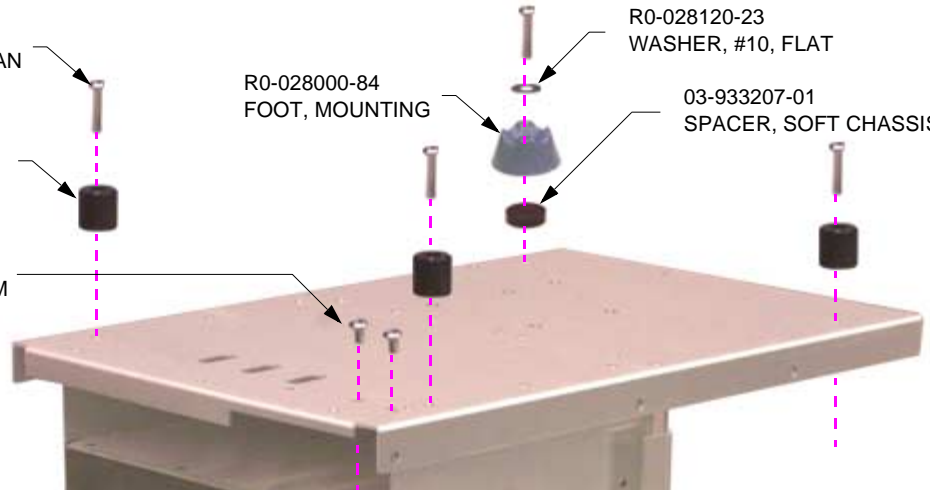

LOWER HINGE BRACKET INSTALLATION

03-933181-01 BRACKET, LOWER HINGE

14-999410-00 WASHER, TEFLON .177ID



03-933180-01 BRACKET, UPPER HINGE

12-901165-00, 2 PLCS SCREW, 8-32 X 1/4, SEMs

03-933010-01 ASSY, CHASSIS

UPPER HINGE BRACKET INSTALLATION

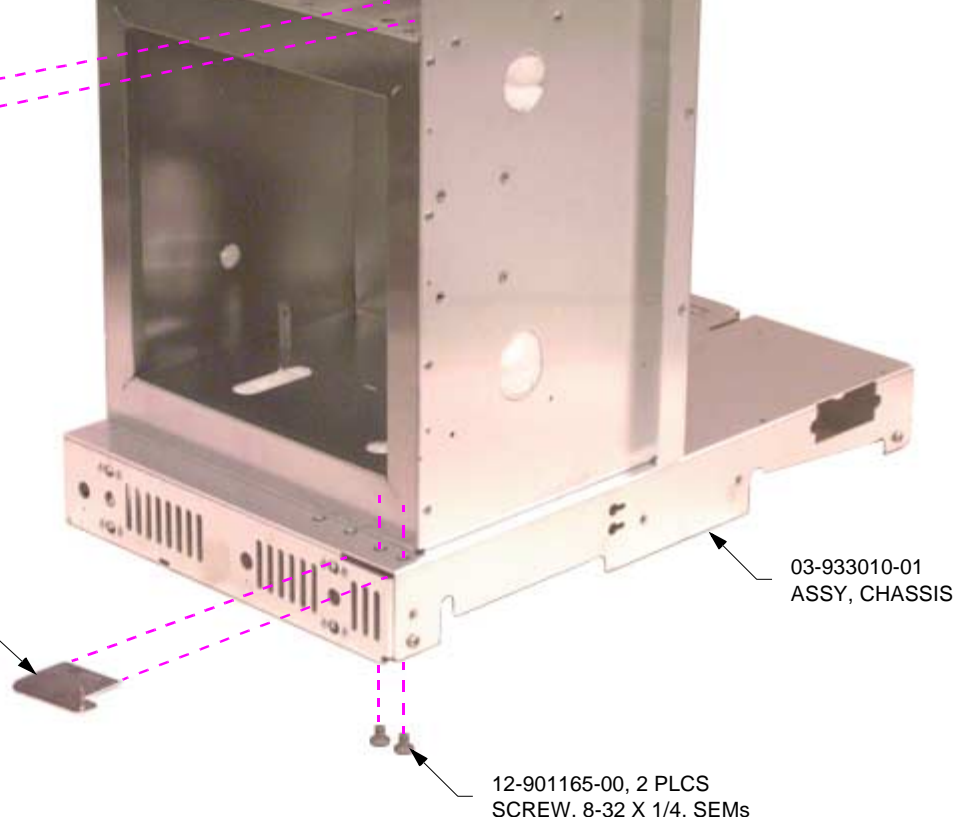

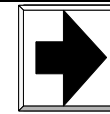
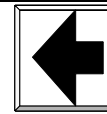
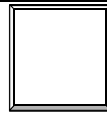

1. 3900 GALILEO BASIC (ELECTRICAL) ASSEMBLY PROCEDURES

1.1 RUBBER FOOT/DOOR HINGE INSTALLATION

- 1.1.1 Place chassis assembly, 03-933010-01 upside down. Install 3 each 8-32 X 3/4" screws, 12-222008-12 into 3 each plastic foot, 03-925315-02 and secure one foot/screw assembly into each front corner of chassis and one foot/screw assembly into the back left corner of chassis as shown.
- 1.1.2 Install one each foot, R0-028000-84, one each washer, R0-028120-23 and one each Spacer, 03-933207-01 to right rear corner of chassis using one each 8-32 X 3/4" Screw, 12-222008-12 as shown.
- 1.1.3 Install lower hinge bracket, 03-933181-01 using two each 8-32 X 3/8" screws, 12-901163-00 as shown.
- 1.1.4 Turn chassis upright and place Teflon washer, 14-999410-00 onto pin of lower hinge bracket 03-933181-01.
- 1.1.5 Install upper bracket, 03-933180-01 onto chassis using two each 8-32 X 1/4" screws, 12-901165-00 as shown.

Continue Next Page

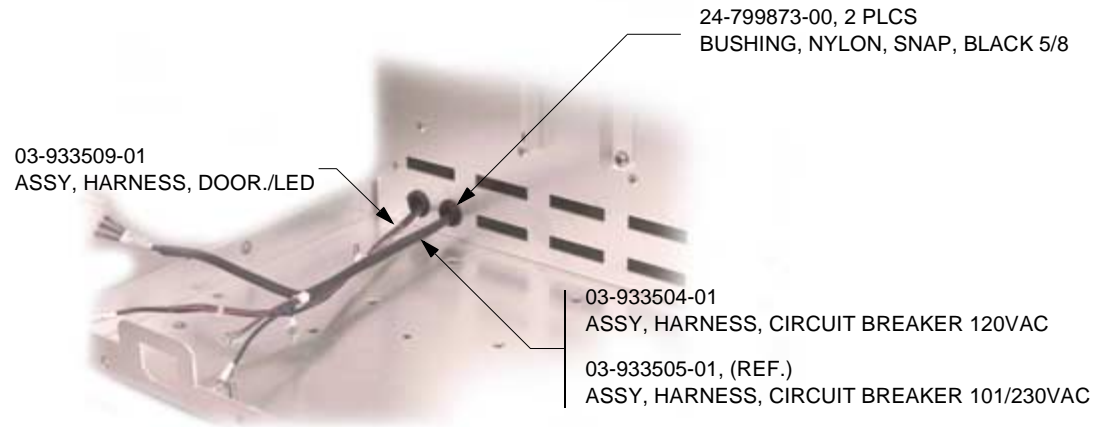
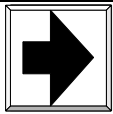
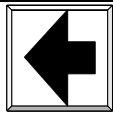

POWER SWITCH HOUSING (REF.)

REAR VIEW (REF.)

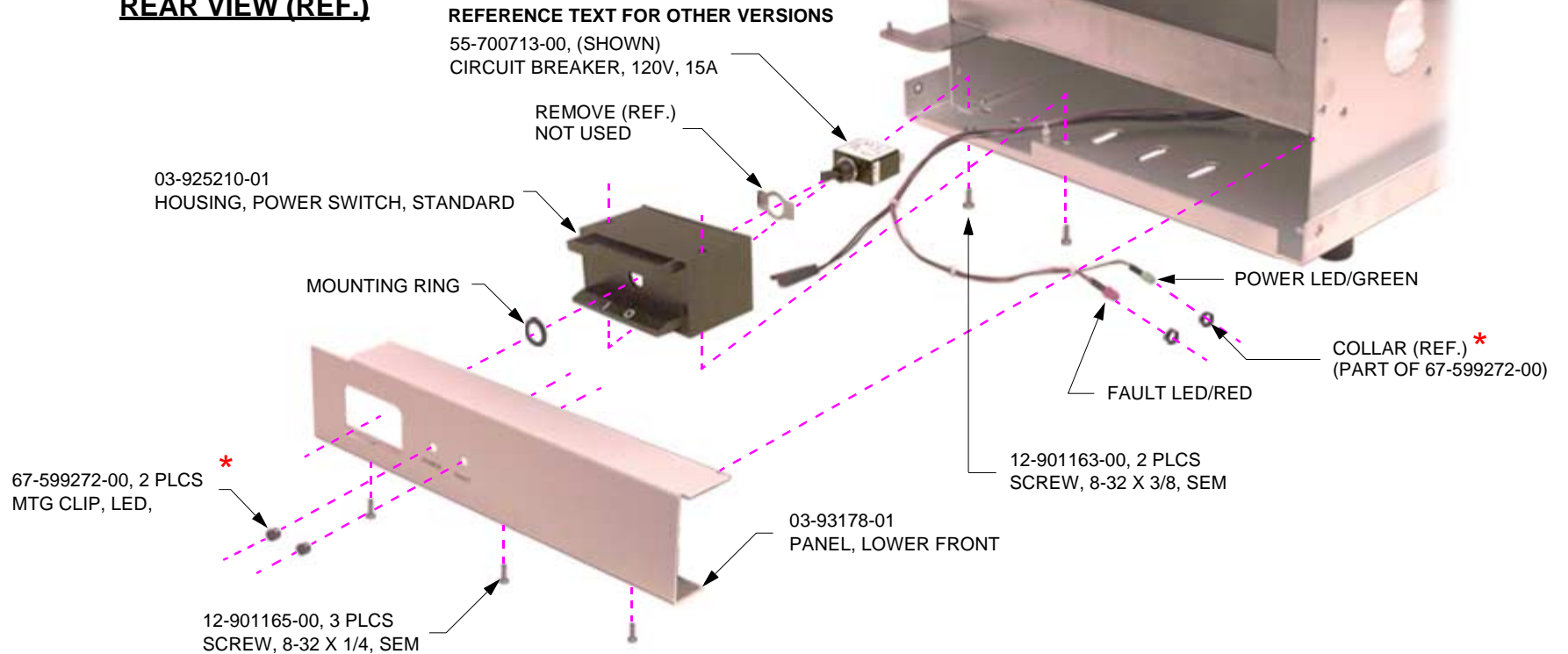

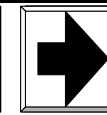
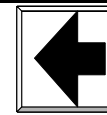
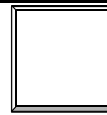

1.2 CIRCUIT BREAKER/WIRING HARNESS INSTALLATION

- 1.2.1 Route 1/4" quick-connect lugs of appropriate circuit breaker harness, 03-933504-01 (for 120VAC) 03-933505-01 (for 101/230VAC) through innermost hole of the rear chassis panel as shown.
- 1.2.2 Route the RED/GREEN LED and magnetic sensor of Door/LED harness, 03-933509-01 through outermost hole of the rear chassis panel as shown.
- 1.2.3 Install a split grommet, 24-799873-00 over the circuit breaker harness and snap into outer oven rear chassis panel as shown. Repeat this step for the Door/LED harness.
- 1.2.4 Install the appropriate circuit breaker: 55-700713-00 (for 120VAC); 55-700714-00 (for 230VAC); 55-700715-00 (for 101VAC) into power switch housing, 03-925210-01 as shown. Secure using special wrench T# 8983.
- 1.2.5 Plug 1/4" quick-connect lugs from circuit breaker harness onto circuit breaker. Note that the numbered label on the lug matches the number on the circuit breaker. Make sure circuit breaker is in the OFF (0) position.
- 1.2.6 Position the chassis assembly, 03-933010-01 on its back and secure power switch housing, 03-925210-01 to chassis using two each 8-32 X 3/8" screws, 12-901163-00 as shown.
- 1.2.7 Obtain lower front panel, 03-933178-01 and snap in two each LED mounting clips, 67-599272-00 in the holes labeled "POWER" and "FAULT".
- 1.2.8 Place one LED mounting collar over each of both the red and green LED's of the Door/LED harness, 03-933509-01. Snap the green LED into the mounting clip in hole labeled "POWER" and secure LED with mounting collar. Snap the red LED into the mounting clip in hole labeled "FAULT" and secure with mounting collar.
- 1.2.9 Route the magnetic switch from the Door/LED harness out the right side of the lower front panel, 03-933178-01 and secure panel to chassis using three each 8-32 X 1/4" screws, 12-901165-00.

Continue Next Page

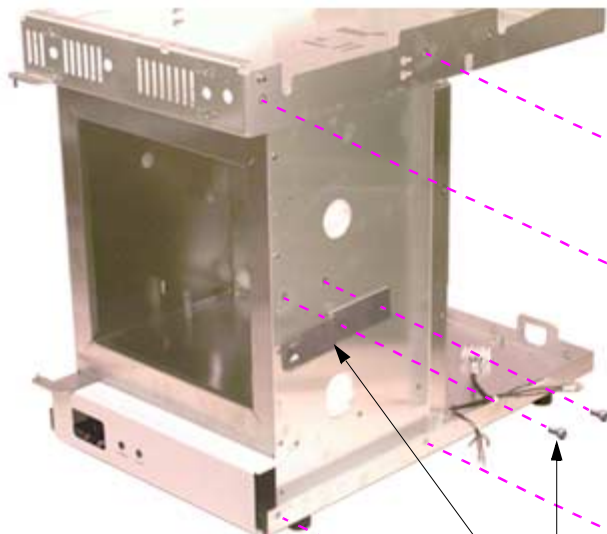
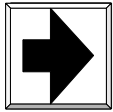
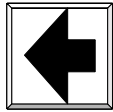

MAGNETIC SWITCH (REF.)

03-933158-01
DOOR CATCH

12-901165-00, 2 PLCS
SCREW, 8-32 X 1/4, SEM

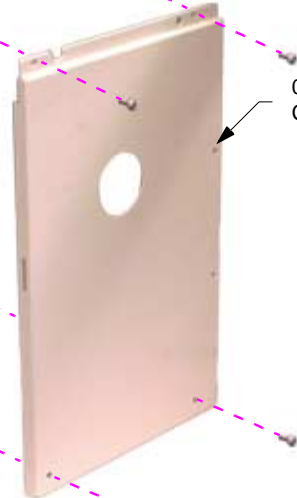

03-933174-01
COVER, RIGHT SIDE OVEN

12-902733-00, 4 PLCS
SCREW, 8-32 X 5/16, TRUSS

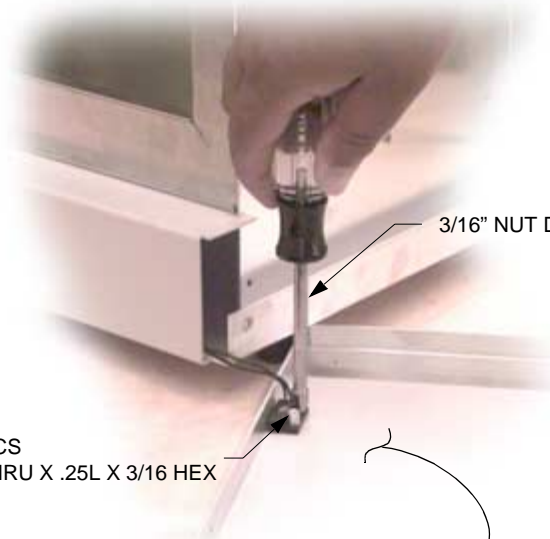

3/16" NUT DRIVER

R0-028000-55, 2 PLCS
STANDOFF, 4-40 THRU X .25L X 3/16 HEX

RIGHT SIDE OVEN
COVER (REF.)

MAGNETIC SWITCH INSTALLATION

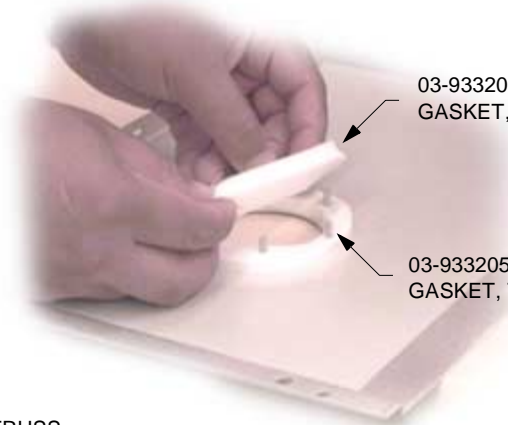

03-933205-03, (THICK)
GASKET, TRANSFERLINE, .37 THK

03-933205-02, (THIN)
GASKET, TRANSFERLINE, .25 THK

GASKETS INSTALLATION

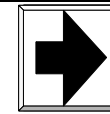
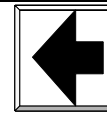
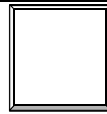

1.3 DOOR CATCH/RIGHT SIDE OVEN COVER INSTALLATION

- 1.3.1 Secure door catch, 03-933158-01 to chassis using two each 8-32 X 1/4" screws, 12-901165-00 as shown.
- 1.3.2 Place one (thin) .25 thk Transferline Gasket (03-933205-02) over stud mount with large hole on the Right Side Oven Cover. Place an other (thick) .37 thk Transferline Gasket (03-933205-03) over previous gasket as shown.
- 1.3.3 Using a 3/16" nut driver, secure magnetic switch to the studs on the right side oven cover, 03-933174-01 using two each 4-40 X 1/4" hex standoffs, R0-028000-55.
- 1.3.4 Secure right side oven cover, 03-933174-02 to chassis using four each 8-32 X 5/16" truss screws, 12-902733-00. One in each corner of panel as shown. Door Catch should pass through slot in front flange of right side cover. Check alignment of cover. Door catch should not drag against top or bottom of slot when flexed.

Continue Next Page

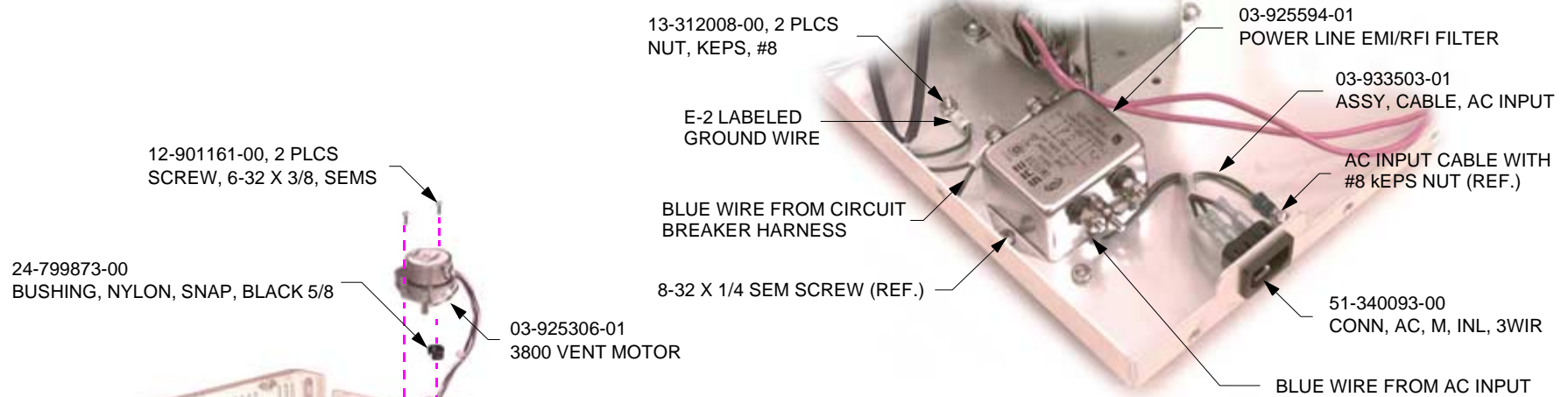
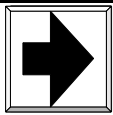
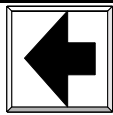

POWER LINE FILTER INSTALLATION

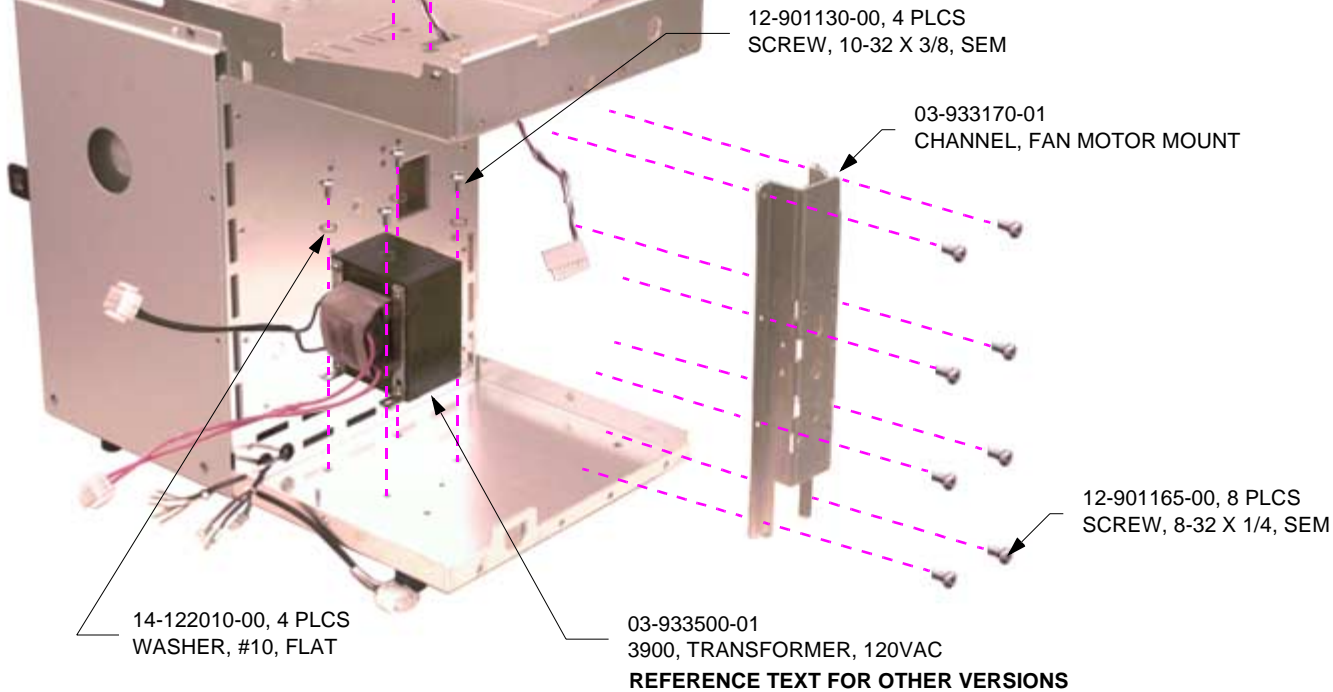

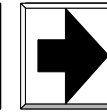
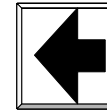
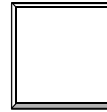

1.4 TRANSFORMER/LINE FILTER/VENT STEPPER MOTOR/WIRING HARNESS INSTALLATION

- 1.4.1 Working from the rear of the chassis, install fan motor channel, 03-933170-01 onto rear oven chassis panel using eight each 8-32 X 1/4" screws, 12-901165-00 as shown.
- 1.4.2 Obtain appropriate transformer, 03-933500-01 (for 120VAC) 03-933501-01 (for 230VAC) and 03-933502-01 (for 101VAC). Secure transformer to chassis using four each 10-32 X 3/8" screws, 12-901130-00 and four each #10 flat washers, 14-122010-00 as shown.
- 1.4.3 With an 11/32" nut driver secure the ground wire (labeled "E2") on the circuit breaker harness to the chassis ground stud next to the transformer using a #8 kep nut, 13-312008-00.
- 1.4.4 Obtain line filter, 03-925594-01 and remove the first nut and all the washers from each of the four AC studs. Using a 11/32" nut driver gently tighten down the remaining nuts.
- 1.4.5 Attach the AC input cable, 03-933503-01 to the side of the line filter labeled "LINE" using two of the previously removed flat washers and two each #8 kep nuts, 13-312008-00 as shown.
- 1.4.6 Secure the blue and brown wires from the circuit breaker harness to the side of the line filter labeled "LOAD" using the same hardware referenced in the previous step.
- 1.4.7 Mount the line filter to the chassis using two each 8-32 X 1/4" screws, 12-901165-00 as shown.
- 1.4.8 Plug 1/4" quick-connects from the AC input cable, 03-933503-01 into line cord receptacle, 51-340093-00 as shown. Snap receptacle into chassis.
- 1.4.9 Secure ground wire from AC input cable to stud on chassis using one each #8 kep nut, 13-312008-00.
- 1.4.10 Route connector of vent stepper motor, 03-925306-01 through the rectangular opening on top of chassis. Place split grommet, 24-799873-00 over motor wires and snap into chassis.
- 1.4.11 Secure stepper motor to chassis using two each 6-32 X 3/8" screws, 12-901161-00.

Continue Next Page

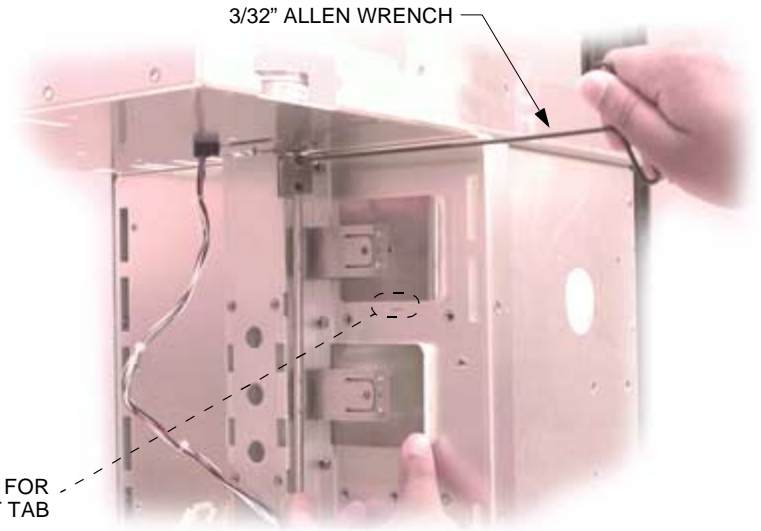
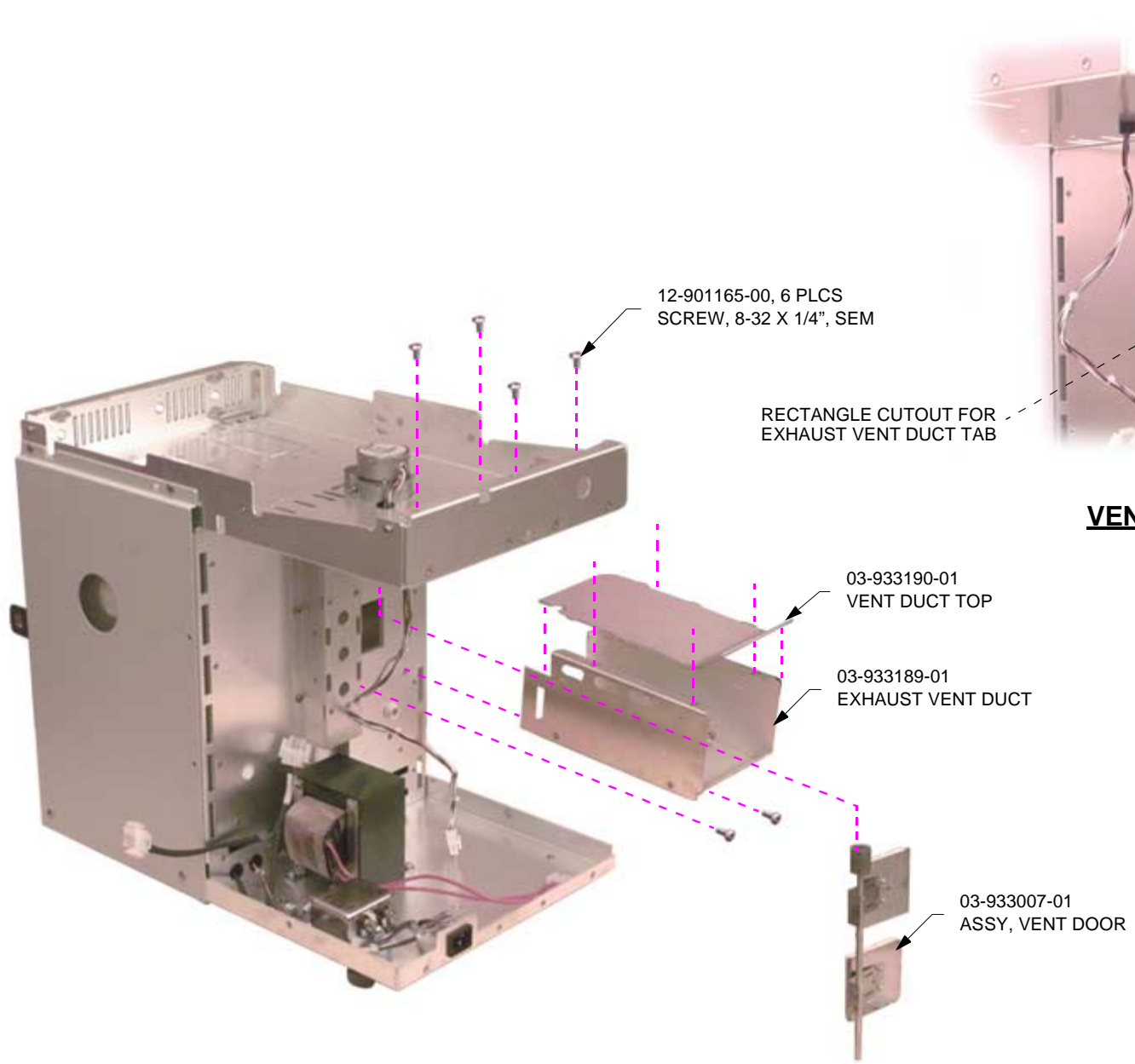
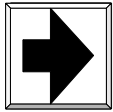
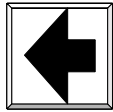

VENT DOOR INSTALLATION

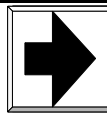
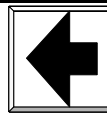
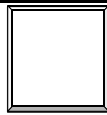
**1.5 DOOR VENT/VENT DUCT INSTALLATION**

- 1.5.1 Obtain vent door assembly, 03-933007-01 and place the flex coupler onto the stepper motor shaft. Tighten coupler set screw using a 3/32" Hex Key. Make sure vent door assembly is pushed up fully prior to tightening Hex Socket Cap screw to 8-9 inch-lbs torque.
- 1.5.2 Snap the vent duct top, 03-933190-01 into the exhaust vent duct, 03-933189-01 as shown.
- 1.5.3 Place vent duct assembly around vent door shaft and secure using six each 8-32 X 1/4" screws, 12-901165-00 as shown. Make sure tab of vent duct assembly is inserted into rectangular hole in rear chassis panel.

Continue Next Page

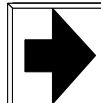
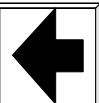

INSTALL MOTOR IN ORIENTATION AS SHOWN

03-933196-01
INTAKE DUCT

INTAKE DUCT
ARM SUPORT

22-119785-00
CLAMP, CABLE 1/8"

REFERENCE TEXT FOR OTHER VERSIONS

03-933012-01
ASSY, COLUMN OVEN MOTOR, 120V

03-933162-01
BRACKET, VENT SHAFT

21-128961-00
BEARING, NYLON SLEEVE

12-901165-00, 10 PLCS
SCREW, 8-32 X 1/4, SEMS

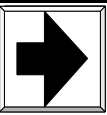

1.6 DOOR VENT/VENT DUCT INSTALLATION

- 1.6.1 Make all the proper bends in intake duct, 03-933196-01 per template.
- 1.6.2 Place intake-duct around vent door shaft and secure first with 2 each 8-32 X 1/4" screws, 12-901165-00 into exhaust vent duct, 03-933189-01 as shown.
- 1.6.3 Snap nylon bearing sleeve, 21-128961-00 into vent shaft bracket 03-933162-01 as shown.
- 1.6.4 Secure vent shaft bracket and intake duct to rear oven chassis using three each 8-32 X 1/4" screws, 12-901165-00 as shown.
- 1.6.5 Weave intake duct arm support into notched opening as shown. Loosely secure support to intake duct using one each 8-32 X 1/4" screws, 12-901165-00 and one each cable clamp, 22-119785-00 as shown.
- 1.6.6 Install appropriate column fan motor assembly, 03-933012-01 (for 120VAC), 03-933012-02 (for 230VAC) and 03-933012-03 (for 101VAC) to channel, 03-933170-01 using four each 8-32 X 1/4" screws, 12-901165-00. Motor wires should be located closest to the line filter.

NOTE: Verify there are 2 each vibration isolators supporting the bottom of the fan motor assembly.



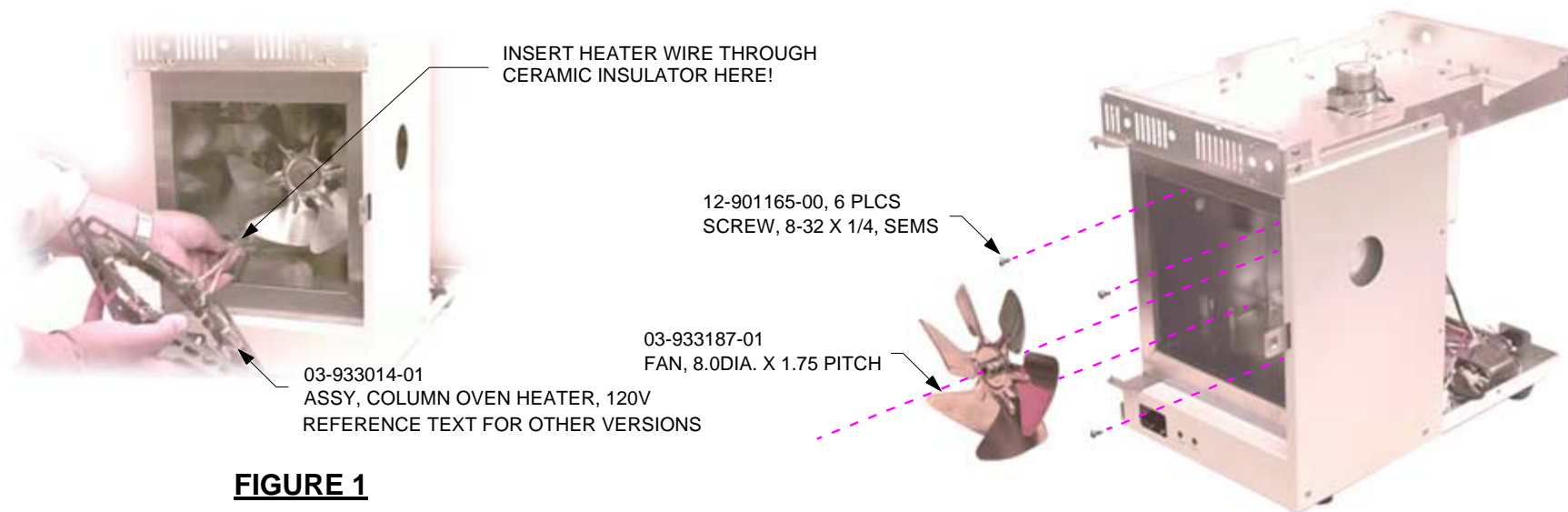
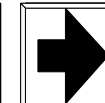
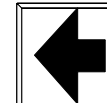
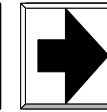
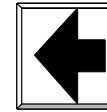
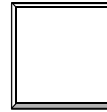

FIGURE 1



FIGURE 2



1.7 FAN BLADE/HEATER ASSEMBLY/TEMPERATURE PROBE INSTALLATION

- 1.7.1 Insert Shipping Pin, 03-933198-01 to support column fan motor. Install fan blade 03-933187-01 onto motor shaft with set screw on the motor shaft flat at 12:00 and the other set screw at 3:00. Loosely tighten the set screw at 12:00 with a 1/8" Allen Wrench. Slide fan back until it stops on rounded part of motor shaft and firmly tighten both set screws, while supporting the mtor shaft. Remove Shipping Pin.
- 1.7.2 Loosely install 2 each 8-32 X 1/4" screws, 12-901165-00 into both upper column oven heater mounting brackets.
- 1.7.3 Obtain the appropriate heater assembly, 03-933014-01 (for 120VAC), -02 (for 230VAC) and -03 (for 101VAC). Route the two heater wires from the heater assembly through the ceramic insulator in the lower left rear of oven. Hook oven baffle onto the two each 8-32 X 1/4" screws, 12-901165-00 installed in previous step. Secure heater assembly using two additional 8-32 X 1/4" screws, 12-901165-00 in both lower corners. Tighten all four mounting screws.
- 1.7.4 Secure column oven heater wires to rear chassis of oven using one each clamp, 22-119918-00 and one each 8-32 X 1/4" screws, 12-901165-00 as shown.
- 1.7.5 Plug each of the contacts of the two column oven heater wires into connector housing. 51-408249-00. NOTE: There is no polarity, so either wire can go into either connector position.
- 1.7.6 Carefully route column oven wires between the transformer and the rear oven chassis as shown.
- 1.7.7 Use a sharp tool to poke down through the column oven probe hole in the top of the oven chassis. Remove by hand any excess insulation inside the oven.
- 1.7.8 Install column oven temperature probe assembly, 03-925375-03 into probe hole in top of oven chassis and secure using one each clamp, 22-119785-00 and one each 8-32 X 1/4" screws, 12-901165-00 as shown. NOTE: Installing probe may require a slight adjustment to the heater assembly, 03-933014-0X.
- 1.7.9 Route column temperature probe connector through the keyhole slot in the right side of the chassis top. Place a Split Grommet, 24-799873-00 around probe wires and snap into chassis top.

Note: Poke a long phillips head screw driver through hole first to make room in the insulation for wires.

Continue Next Page

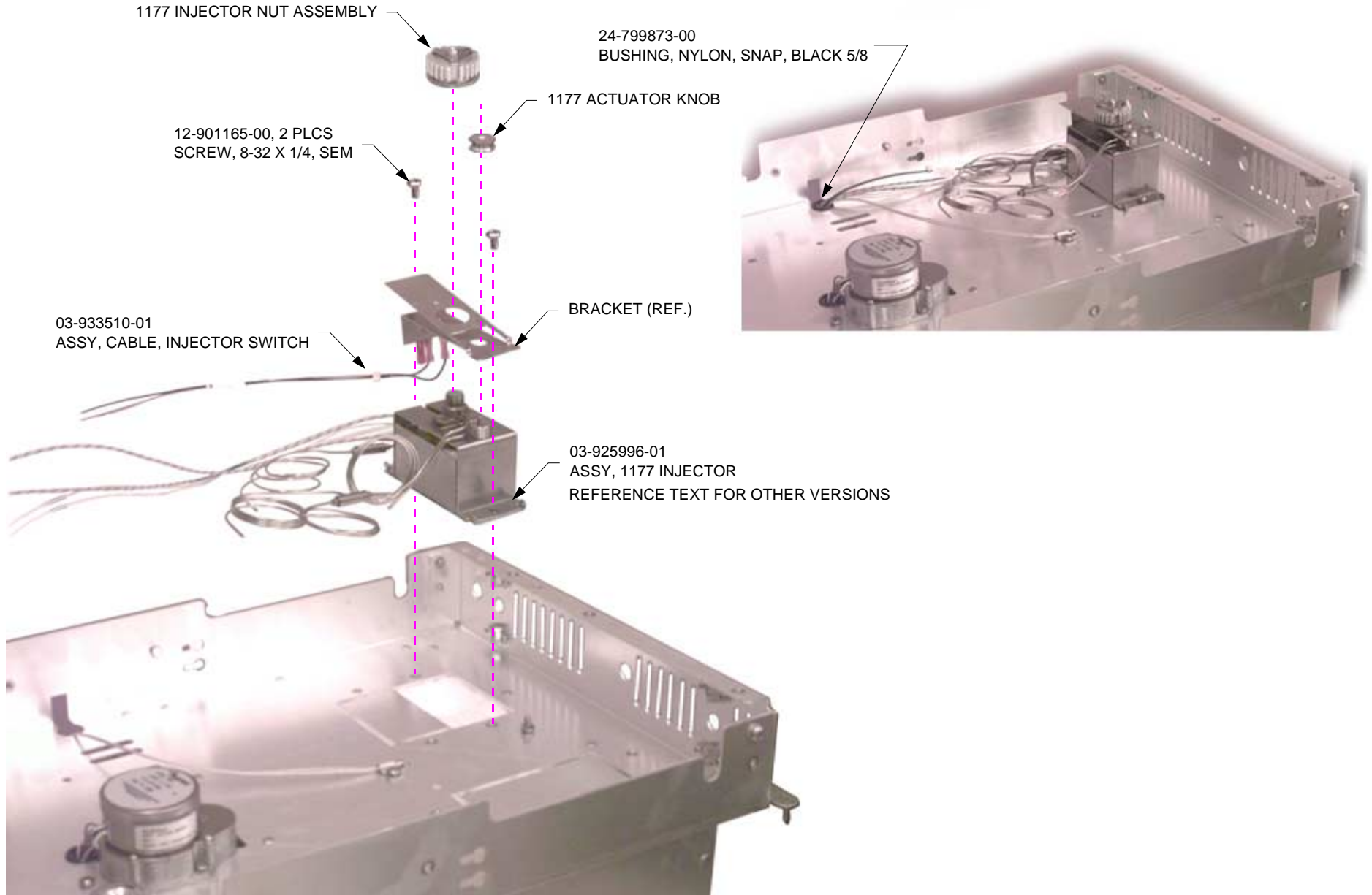
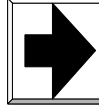

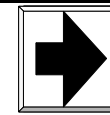
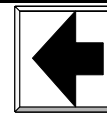
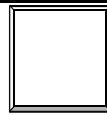

1.8 1177 INJECTOR INSTALLATION

- 1.8.1 Obtain the appropriate 1177 injector, 03-925996-01 (for 120VAC, Type 21), 03-925996-02 (for 230VAC, Type 21) and 03-925996-03 (for 101VAC, Type 21) or 03-925997-01 (for 120VAC, Type 25), 03-925997-02 (for 230VAC, Type 25) and 03-925997-03 (for 101VAC, Type 25).. Attach injector switch cable assembly, 03-933510-01 to the micro switch of the 1177 injector. Connect the BROWN wire to the center tab of the switch and BLACK to the remaining tab.
- 1.8.2 With the proper clearance in the column oven insulation, install the 1177 injector onto the top of the oven chassis using two each 8-32 X 1/4" screws, 12-901165-00 as shown. Install Test Injector Cover, 03-933013-01 to insure proper alignment of 1177 Injector. If required, loosen injector mountings screws and adjust accordingly.
- 1.8.3 Route the 1177 injector heater, RTD and injector switch wires through the keyhole slot in the right side of the chassis. Place a split grommet, 24-799873-00 around the 1177 and column temperature probe wires and snap into chassis top.
- 1.8.4 Bundle the 1177 injector and column probe wires together and secure to chassis top using one each Nylon Clamp, 22-119944-00 and one each 8-32 x 1/4 Screw, 12-901165-00.

Continue Next Page

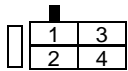
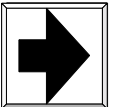
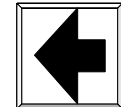

CONN. DETAIL

1177 HEATER CONTACTS
WIRE TO PINS 2 & 4

1177 INJECTOR PROBE WIRE
WIRE TO PIN 1 & 11

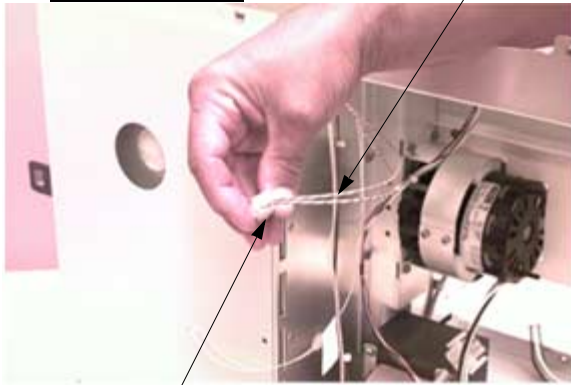

STEP 1.9.1

51-406927-00
CONNECTOR HOUSING, 4 PIN

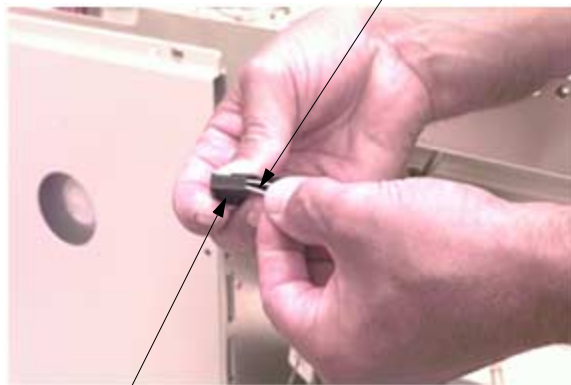

STEP 1.9.2a

OVEN COLUMN
TEMPERTURE PROBE CONN.

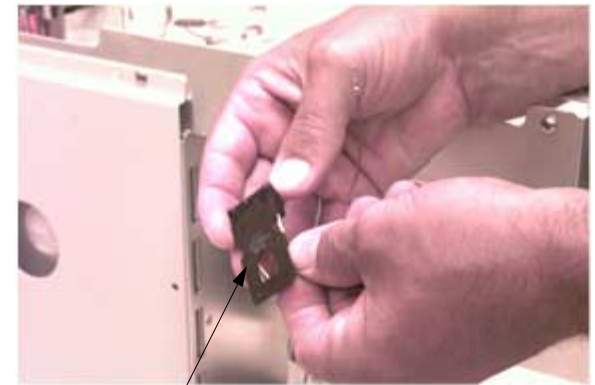

STEP 1.9.2b

INJECTOR SWITCH CABLE
WIRE TO PIN 10 BLK & 20 BRN



STEP 1.9.3

REFER TO DIAGRAM
FOR CONNECTOR POSITION



STEP 1.9.4

22-119650-00, 2 PLCS
TY-WRAP, NYLON, NATURAL, SHORT (MPB)

DOOR/LED & STEP MOTOR HARNESS

22-120322-00, 2 PLCS
CLAMP, CABLE, STANDOFF

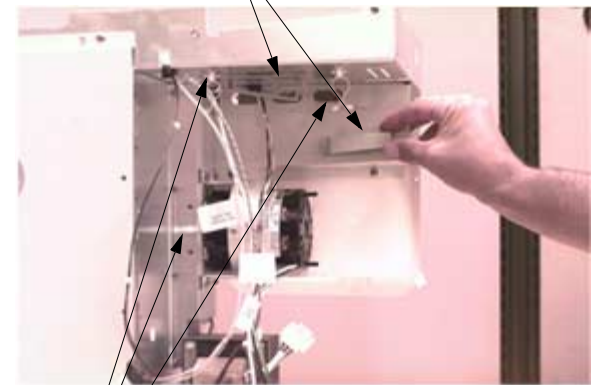
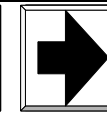
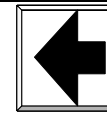
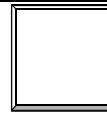

Figure 1.9.5

22-300001-00, 3 PLCS
STANDOFF, CABLE CLAMP



1.9 FINAL WIRING/CONNECTIONS

- 1.9.1 Obtain 4-pin connector housing, 51-406927-00 and install the 1177 heater contacts into pins 2 and 4 as shown. NOTE: There is no polarity requirement.
- 1.9.2 Install the contacts from the 1177 injector probe into pin 1 and 11 and the injector switch cable wires into pins 10 (BLACK) and pin 20 (BROWN) on the 20-pin connector attached to the column oven temperature probe assembly, 03-925375-03.
- 1.9.3 Place the six wires from the Door/LED harness assembly, 03-933509-01 into the 18-pin connector on the stepper motor assembly, 03-925306-01. Attach wires as follows: Pin 4 - WHT/BRN, Pin 5 - BRN, Pin 6 - BLK, Pin 13 - GRN, Pin 14 - Red, Pin 16 - BLK. NOTE: There is no polarity requirement for black wires. Reference wiring diagram below.
- 1.9.4 Install two each tie wraps, 22-119650-00 around the Door/LED and stepper motor harnesses. Place one approximately 2 inches and one approximately 6 inches from the 18-pin connector.
- 1.9.5 Obtain two each cable clamps, 22-120322-00. Snap one clamp into the hole in the exhaust duct, 03-933189-01 and the other into the hole on the bottom side of the chassis top, as shown. Obtain three each standoff cable clamp, 22-300001-00. Snap one each into the center hole of channel, 03-933170-01. Snap the other two into the bottom of the chassis top as shown.

NOTE: * WIRES PREVIOUSLY INSTALLED

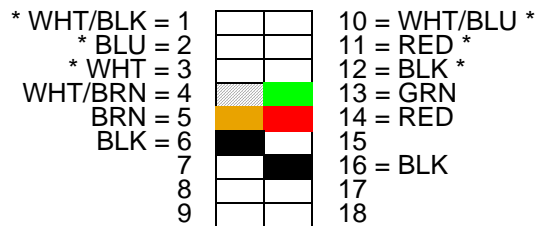

WIRING DIAGRAM FOR STEP 1.9.3

Continue Next Page

VENT STEPPER MOTOR WIRE THROUGH HERE

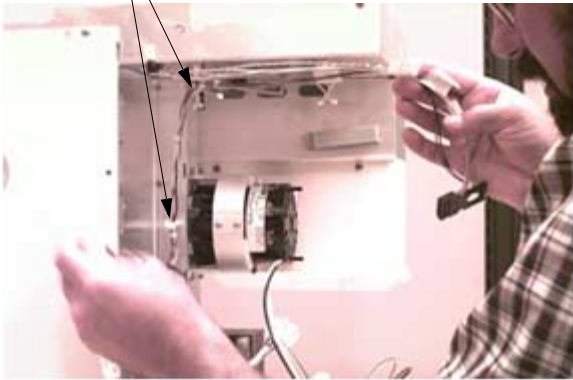

STEP 1.10.1

COLUMN MOTOR WIRE THROUGH HERE

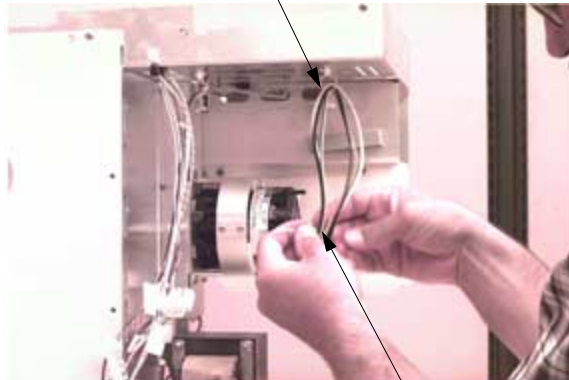

STEP 1.10.2



STEP 1.10.3

PROBE/INJECTOR WIRE THROUGH HERE

22-119650-00
TY-WRAP, NYLON, NATURAL, SHORT (MPB)

"P3 TO MAIN BOARD"

03-933508-01
ASSY, CABLE, EFC, 3900



STEP 1.10.4a

"P1 TO EFC"

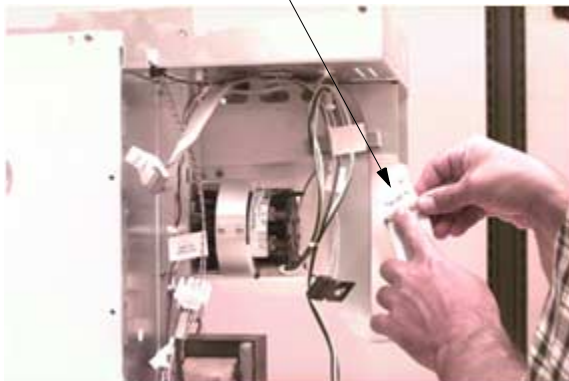

STEP 1.10.4b

14-901030-00, 2 PLCS
WASHER, #10 FLAT, SST

12-901161-00, 2 PLCS
SCREW, 6-32 X 3/8, SEM

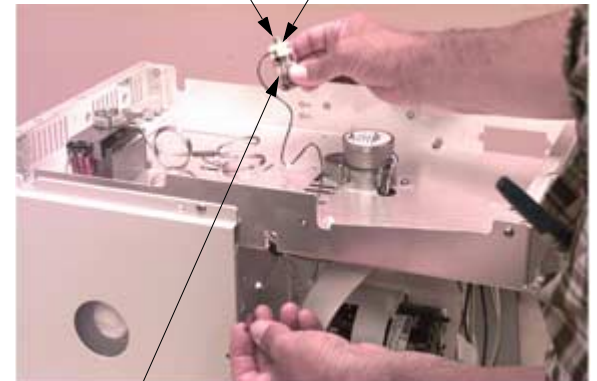

STEP 1.10.5

03-925467-03
SOLENOID, 3900 POWER FAIL



1.10 FINAL WIRING/CONNECTIONS

- 1.10.1 Route the vent stepper motor wires through the cable clamps on the chassis top and channel, 03-933170-01 and twist.
- 1.10.2 Route the column fan motor wires through the standoff clamp closest the exhaust duct and twist. Place a tie wrap, 22-119650-00 around both sets of fan wires, approximately 6 inches from chassis top.
- 1.10.3 Route the column oven probe/injector probe and switch wires through the flat cable clamp on the bottom of chassis top.
- 1.10.4 Obtain EFC flat ribbon cable 03-935508-01 and route cable through both clamps, 22-120322-00. Observe labels at each end of cable for proper orientation.
- 1.10.5 Install 2 each 6-32 X 3/8" screws 12-901161-00 and 2 each #10 washers, 14-901030-00 onto power fail solenoid, 03-925467-03 as shown. Lay solenoid on left side of chassis top and route the solenoid wires through the split grommet currently protecting the 1177 and column probe wires.

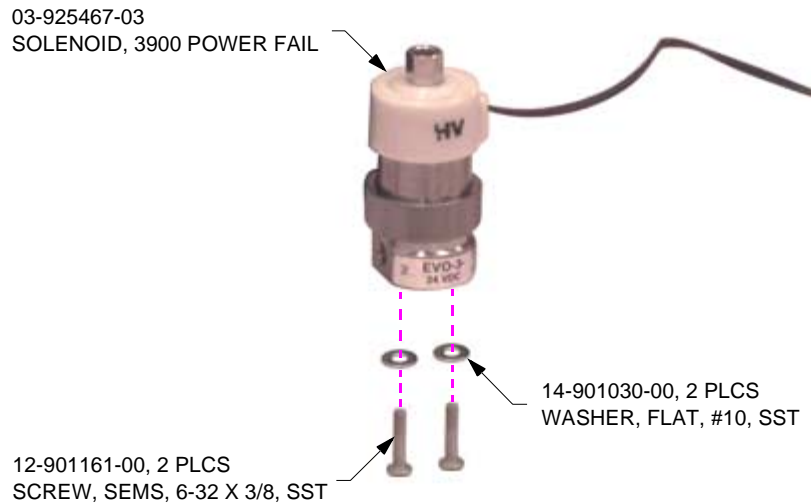

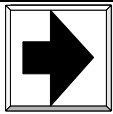
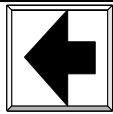

COLUMN PROBE/INJECTOR PROBE
AND SWITCH CONNECTOR (J1)

EFC FLAT CABLE (J3)

POWER FAIL SOLENOID
CONNECTOR (J21)

TRANSFORMER SECONDARY
CONNECTOR (J15)

03-933006-01
ASSY, ELECTRONICS MODULE

TRANSFORMER
PRIMARY CONNECTOR (J18)

CIRCUIT BREAKER CONNECTOR (J19)

DOOR/LED AND STEPPER
MOTOR 18-PIN (J6)

INJECTOR HEATER
CONNECTOR (J13)

COLUMN FAN MOTOR (J16)

COLUMN HEATER CONNECTOR (J17)

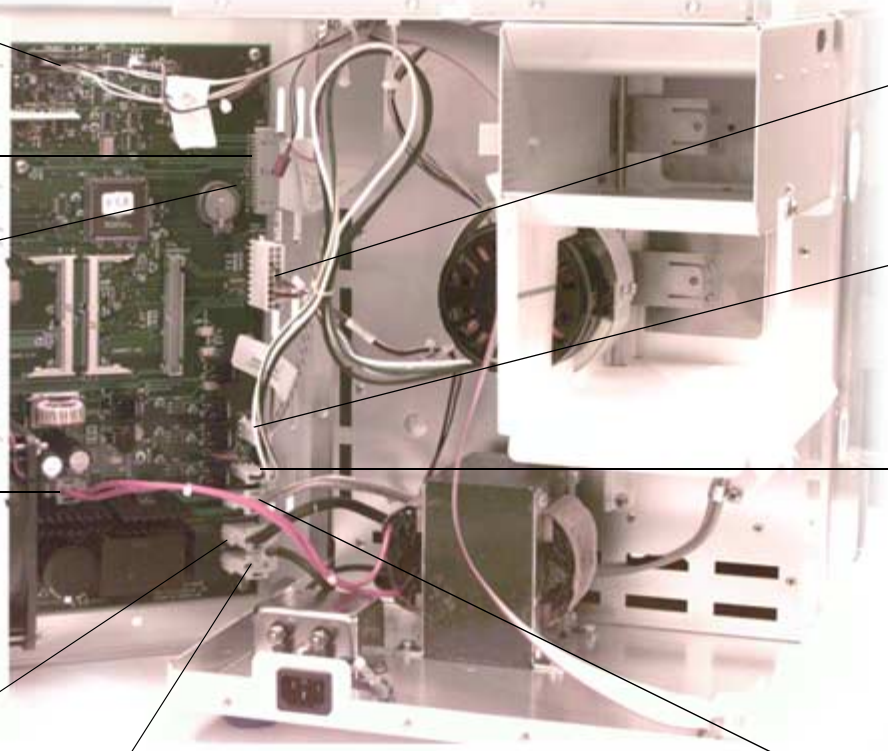

1.11 FINAL WIRING/CONNECTIONS

1.11.1 Obtain electronics module assembly, 03-933006-01 and set into position next to the rear of instrument. Starting from the bottom, plug the circuit breaker connector into J19 and the transformer primary connector into J18. Plug the column oven heater connector into J17 and the column fan motor connector into J16. Plug the injector heater connector into J13 and the transformer secondary connector into J15. Plug the Door/LED /stepper motor 18-pin connector into J6 and the EFC flat cable connector into J3. Plug the power fail solenoid connector into J21 and the Column/injector probe connector into J1.

Continue Next Page

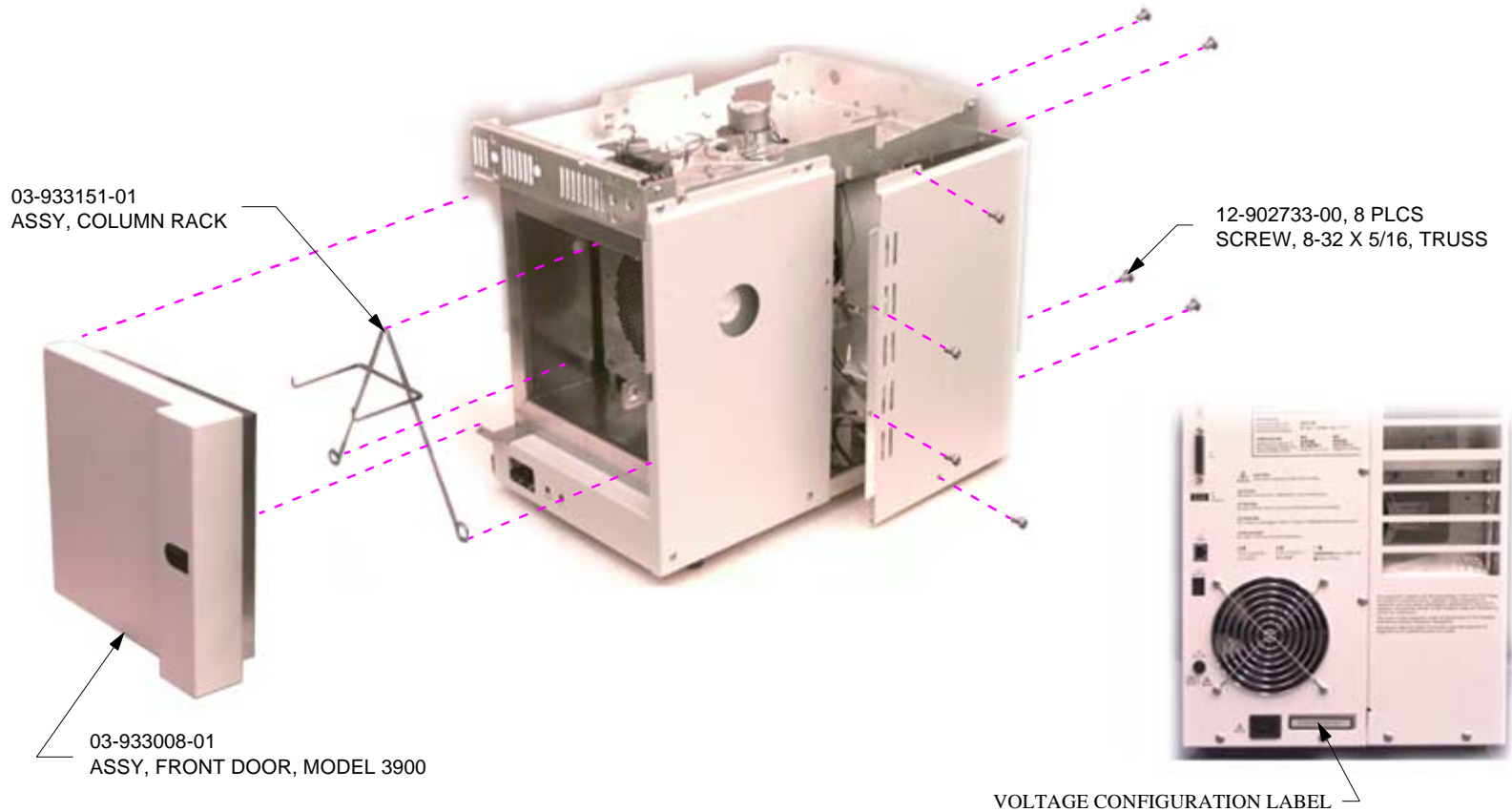
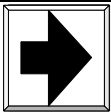
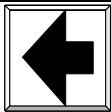

1.12 FINAL ASSEMBLY

REAR PANEL (REF.)

- 1.12.1 Position electronics module assembly onto right rear of chassis and secure using eight each 8-32 X 5/16" screws, 12-902733-00 as shown.
- 1.12.2 Install assembly column rack, 03-933151-01 into the three slots in the column oven as shown.
- 1.12.3 Install front door assembly, 03-933008-01 onto basic assembly. NOTE: Holding door assembly in an "open" orientation, engage top pin first.
- 1.12.4 Install appropriate Voltage Configuration Label (03-935648-03 for 120v, -05 for 230v & -07 for 101v) to right rear chassis in opening of right service cover as shown.

VARIAN



CHG
HISTORY

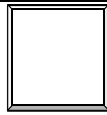

PARTS
LIST

MENU

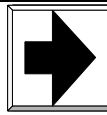
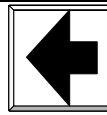

DOC: 03-933001-01

DESC: Assy, Basic Electrical, (120v Shown)

PAGE: 24 of 23

REV

1

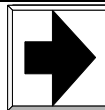
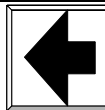

**ASSY, BASIC, (PNEUMATIC)
3900GC STATION #2, ASSEMBLY PROCEDURES**



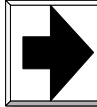

12-901163-00, 4 PLCS
SCR, SEM, 8-32 X 3/8

12-901165-00, 2 PLCS
SCREW, SEM, 8-32 X 1/4



FIGURE 1

03-933508-01
ASSY, CABLE, EFC, 3900GC



FIGURE 2

03-925377-01
3800 PNEUMATICS MANIFOLD

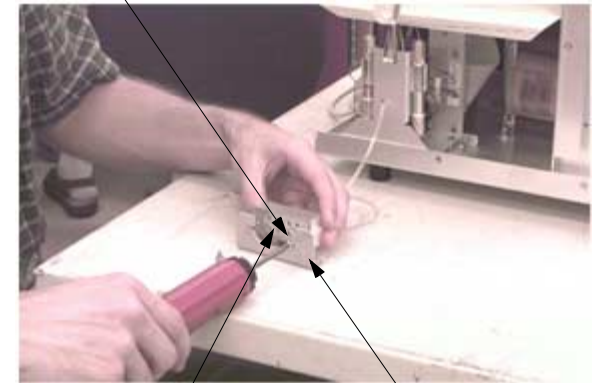

FIGURE 3a

03-933194-01
BRACKET, MANIFOLD

12-901165-00, 2 PLCS
SCREW, SEM, 8-32 X 1/4

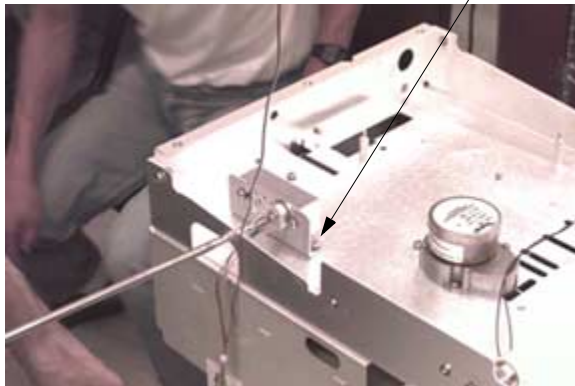

FIGURE 3b

28-693973-00
UNION, BLKHD, 1/8 X 1/8

37-000820-15
1/8" DIAMETER COPPER TUBING, 4.5"

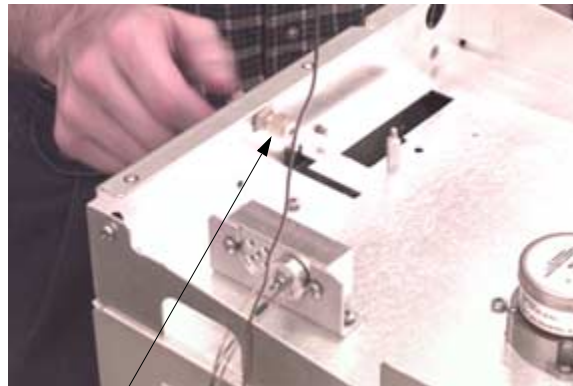

FIGURE 4

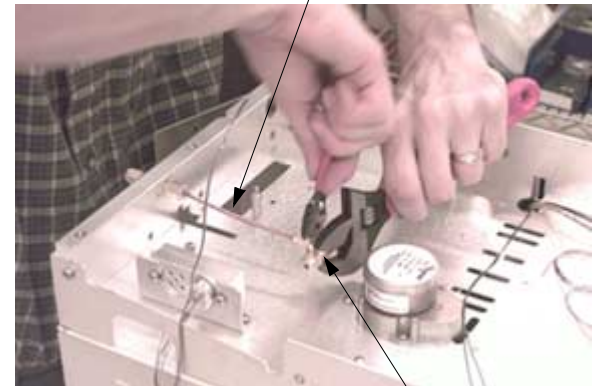
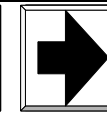
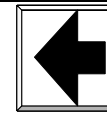
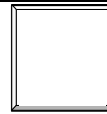

FIGURE 5

28-691944-00
1/8 X 1/8 X 1/8IN TEE-BRASS



1. 3900GC BASIC ASSEMBLY PROCEDURES (PNEUMATIC)

1.1 OPERATION IN SEQUENCE

- 1.1.1 Loosely install four each 8-32 X 3/8" screws, 12-901163-00 into lower chassis as shown. See Figure 1.
- 1.1.2 Plug the EFC ribbon cable, 03-933508-01 into connector J1 on the appropriate EFC sub assembly, 03-933016-21 or 25.
- 1.1.3 Gently lift up intake duct, 03-933196-01 and place appropriate EFC sub assembly onto four screws installed in previous step. Reference Figure 2.
- 1.1.4 Slide EFC sub plate assembly against edge of chassis prior to tightening the four screws.
- 1.1.5 Route EFC tubes through opening in the chassis top and secure with clamp already installed. Be careful not to pinch tubing.
- 1.1.6 Secure manifold bracket, 03-933194-01 to manifold, 03-925377-01 using two each 8-32 X 1/4" screws, 12-901165-00. Secure manifold and bracket to chassis top using another two each 8-32 X 1/4" screws, 12-901165-00 as shown in Figure 3a/b.
- 1.1.7 Connect the light brown (natural) and yellow PEEK tubes, SST tube with green sleeve and pin 03-917143-00 to manifold using four each viton ferrules, 03-917142-00, one each condyne plate, 03-917141-00 and one each 8-32 X 1/2" screws, 12-901150-00 as shown.

Note: For type 25 the yellow peek tubing is replaced with an additional pin.

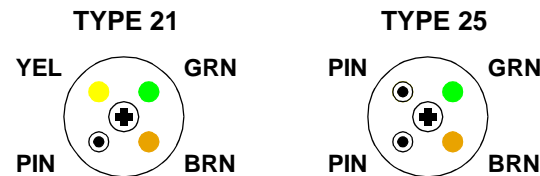

TYPE 21/25 PLUMBING

- 1.1.8 Install bulkhead union, 28-693973-00 to rear chassis top as shown. Secure using 1/2" wrench. See Figure 4.
- 1.1.9 Using a 7/16" wrench swage a four and half inch piece of copper tubing, 37-000820-15 onto bulkhead union. Swage the other end of the copper tubing onto the center position of brass tee, 28-691944-00. Reference Figure 5.

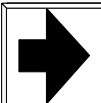
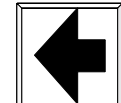

12-901165-00, 2 PLCS
SCREW, SEM, 8-32 X 1/4

03-917157-00
WASHER FERRULE, HOLD USE -50



FIGURE 6

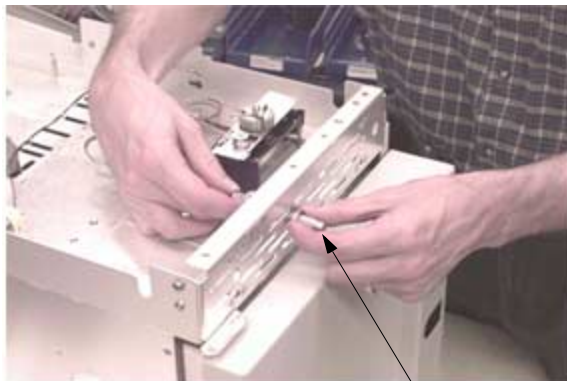

FIGURE 7

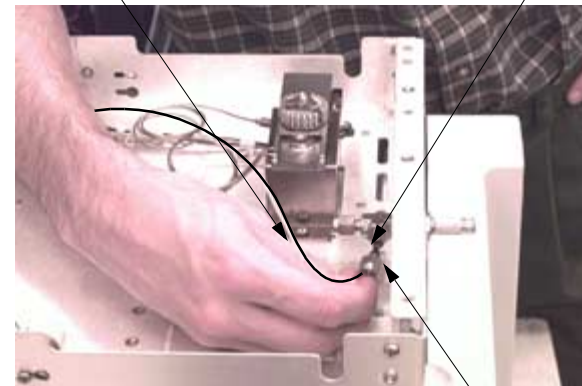

FIGURE 8

57-000028-00
VALVE, NUPRO B-2SA

03-917142-00
VITON FERRULE DISC. USE -50

28-849067-00, 3 PLCS
ADAPT, HOSE, 10-32

03-925467-03
SOLENOID 3900 POWER FAIL

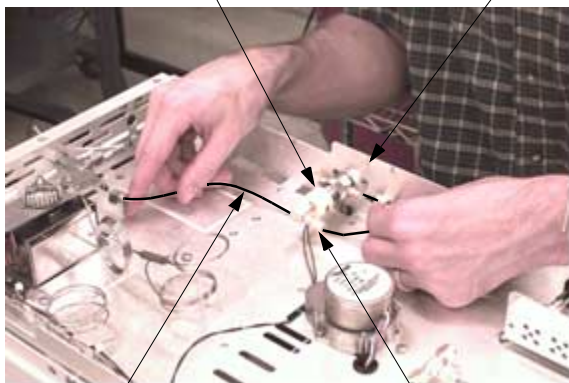

FIGURE 9



FIGURE 10

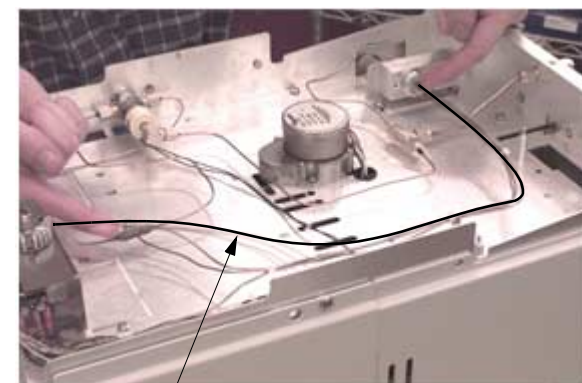
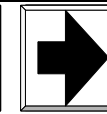
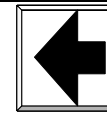
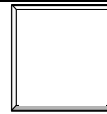

FIGURE 11

03-917145-01
TUBING CONN. 1/16 12IN

28-849969-00
ADAPTER, HOSE, ELBOW

03-918164-03
CARRIER GAS ID (GREEN)



- 1.1.10 Bend the copper tube to position brass tee until it touches the chassis top. Reference Figure 6.
- 1.1.11 Install septum purge valve, 57-000028-00 onto chassis front above column oven as shown. Secure valve with side port pointed away from 1177 injector using a 9/16" wrench. Reference Figure 7.
- 1.1.12 Cut a six-inch section of Teflon tubing, 88-489020-00 and push on a viton ferrule, 03-917142-00 until approximately 1/6" of tubing pokes through the tapered end of the ferrule. NOTE: Cutting the tip of the tubing to a sharp point will help in this difficult process. If you use this technique make sure to re-cut the tip of tubing straight.
- 1.1.13 Remove the side nut and ferrule from the septum purge valve, 57-000028-00 and discard ferrule. Route the Teflon tubing through one each washer, 03-917157-00 and valve nut. Secure the tubing/viton/washer nut assembly to the side port of septum purge valve. Feed the other end of the Teflon tubing through the small hole located on the front chassis top directly above valve not shown.
- 1.1.14 Install one each hose elbow with o-ring, 28-849969-00 and three each hose adapters, 28-849067-00 to the power fail solenoid, 03-925467-03 as shown below.
- 1.1.15 Secure power fail solenoid to left side chassis top using the two 6-32 X 3/8" screws already installed. The #10 washers should be located on the inside between the solenoid and chassis and the "IN/OUT" labeling should be visible on bottom.

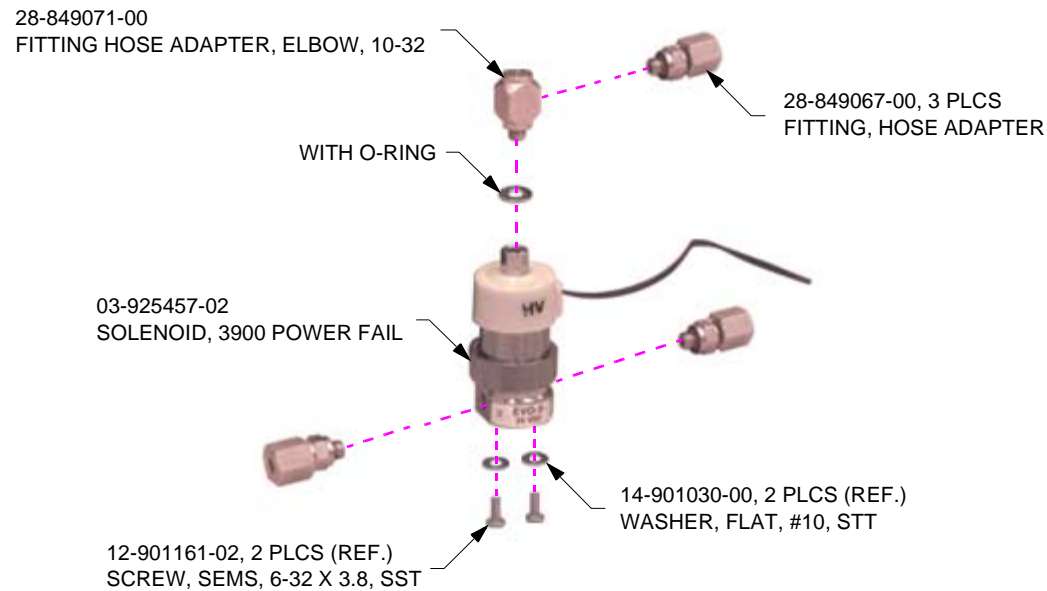

VALVE EXPLODE VIEW

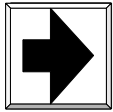
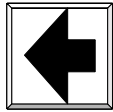

FIGURE 12

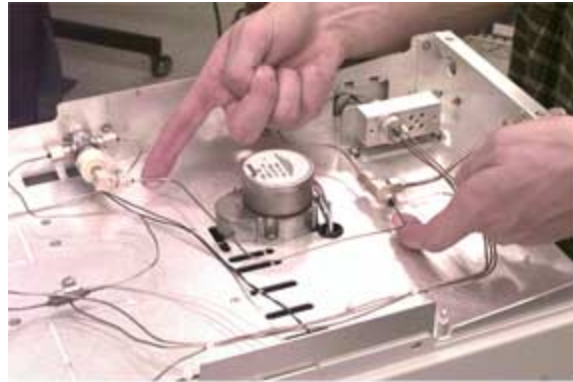

FIGURE 13

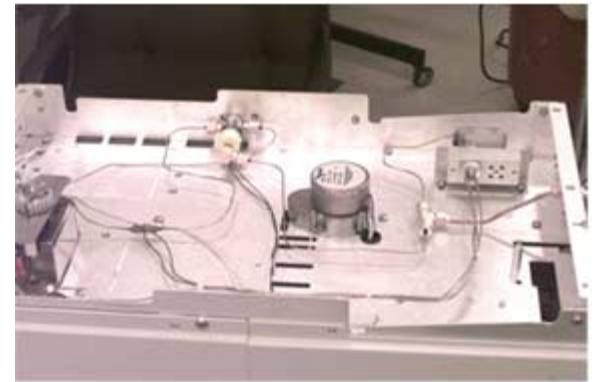
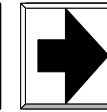
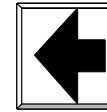
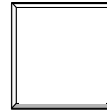
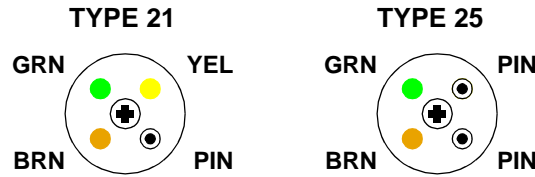

FIGURE 14

- 1.1.16 Route one each 1/16" stainless steel tube 03-917145-01 from the power fail solenoid "OUT" port to the end nut of the septum purge valve, 57-000028-00, using two each washers, 03-917157-00 and 2 each viton ferrules, 03-917142-00 as shown. Discard excess ferrules.
- 1.1.17 Carefully uncoil the four stainless steel tubes from the (Type 21) 1177 injector. Route the single tube (split vent) on the right side of injector down the chassis top and align with the brown (Natural) PEEK tubing on the pneumatics manifold. See Figure 10.
- 1.1.18 Place a green tube identifier, 03-918164-03 to the single SST tube on the 1177 injector, (the only tube that is not teed) route down chassis top and align with the stainless steel tube labeled with the green sleeve on the pneumatics manifold. See Figure 11.
- 1.1.19 For type 21 unit only, place a yellow tube identifier, 03-918163-01 to the SST tube (pressure sense) coming from the middle of the tee on the 1177 injector. Route the tube down chassis top and align with the yellow PEEK tube on the pneumatics manifold.
- 1.1.20 For type 25 only, cut the longer of the two tubes from the injector purge head, two to three inches from injector. Swage a 1/16" SST union, 28-693976-00 onto the remaining short tube. At the other end of union, swage on a 84" SST tube, 03-917145-13. Keep the tubing as coiled as possible and route as described in step 1.1.18.
- 1.1.21 Slide a 1/16" X 3/4" pin, 03-917143-00 through the viton ferrule so that an equal amount of the pin sticks out each end of ferrule. For type 25 units, make two each pin assemblies and position pins into manifold per type 21/25 plumbing diagram below.



1.1.22 Observing the proper alignment (green to green, yellow to yellow, (type 21 only) pin to pin and SST to brown/natural PEEK) place all three tubes through a condyne plate, 03-917141-00. At the end of each tube place one each viton ferrule, 03-917142-00 over the tubing so approximately 1/16" of the tubing sticks out of the tapered end of the viton ferrule. Place pins(s) into proper location(s) and secure condyne plate to manifold with one each 8-32 X 1/2" screw, 12-901150-00.



TYPE 21/25 PLUMBING

- 1.1.23 Route the remaining 1/16" stainless steel tube from the 1177 injector to the port labeled "IN" on the power fail solenoid, 03-925467-03. Attach tube to solenoid using one each washer, 03-917157-00 and one each viton ferrule, 03-917142-00.
- 1.1.24 Attach the remaining 1/16" stainless steel tube from the EFC sub assembly to the brass tee using one each washer, 03-917157-00 and one each viton ferrule, 03-917142-00.
- 1.1.25 Route one each 1/16" stainless steel tube, 03-917145-01 between the remaining port of the brass tee and the power fail solenoid vent. Using two each washers, 03-917157-00 and two each viton ferrules 03-917142-00.
- 1.1.26 Secure the left service cover, 03-933172-01 onto left rear of chassis using eight each 8-32 X 5/16" screws, 12-902733-00. Make sure the clear tubing from the EFC sub assembly sticks through the large obround hole in cover.
- 1.1.27 Secure left side oven cover, 03-933173-01 to chassis using another six each 8-32 X 5/16" screws, 12-902733-00 as shown.
- 1.1.28 Affix the carrier gas label, 03-933201-01 to the left side of bulkhead union on the rear chassis top as shown.
- 1.1.29 Affix the large serial number tag from composite, 03-933204-01 to the right side of bulkhead union on the rear chassis top as shown. Affix the "DATE INSTALLED" and smaller serial number labels to the front chassis top as shown.
- 1.1.30 After completion, Backflush "MS40" the unit per sales order and check list.

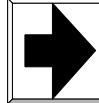

12-902733-00, 14 PLCS
SCREW, 8-32 X 5/16, SS

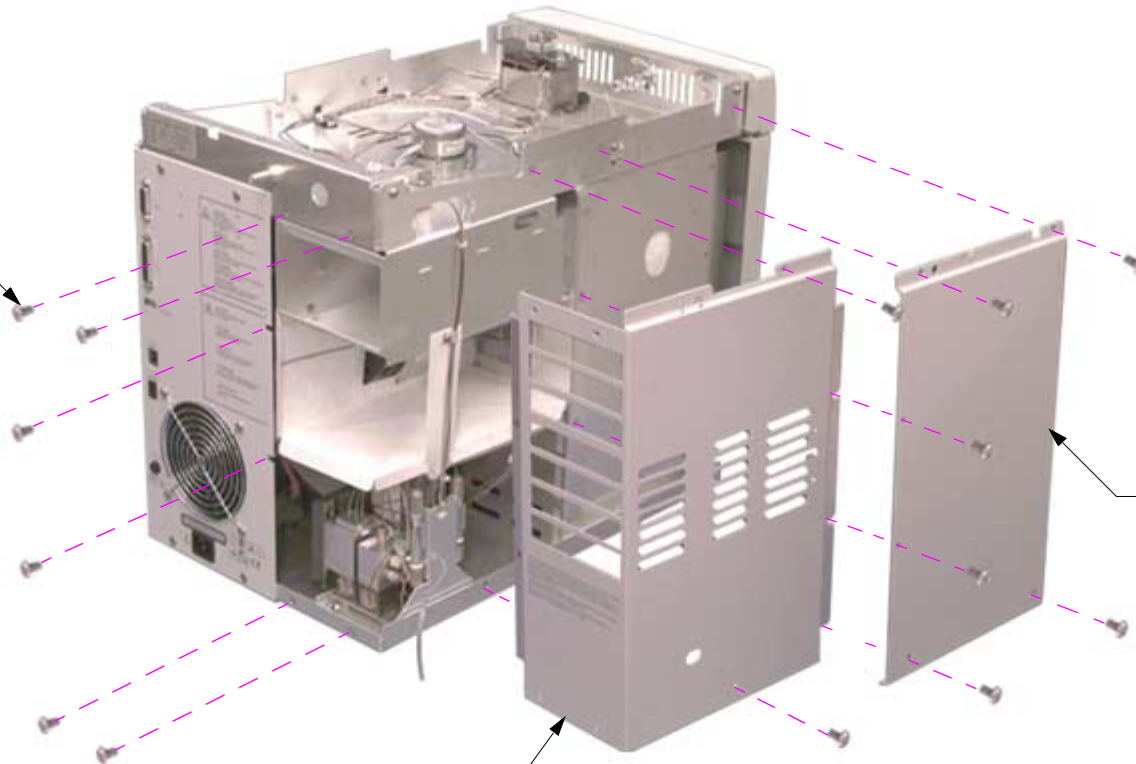

03-933173-01
COVER, OVEN, LEFT SIDE

03-933172-01
COVER, LEFT SIDE SERVICE

03-933201-01
LABEL, MAX PRESS, CARRIER GAS

03-933204-01
LABEL, S/N TAG, MODEL 3900

"DATE INSTALLED" COMPOSITE
LABEL FROM P/N 03-933204-01 (REF.)

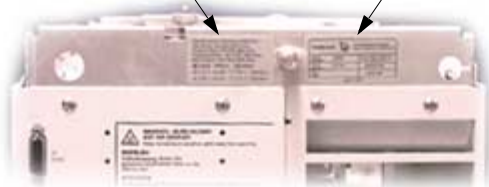

REAR VIEW

SERIAL NUMBER LABEL (SMALL)
P/N 03-933204-01 (REF.)

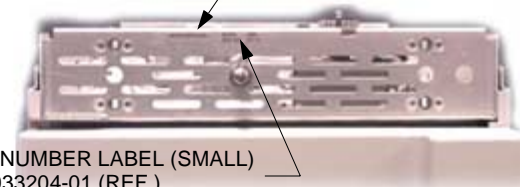

FRONT VIEW

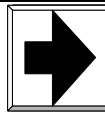
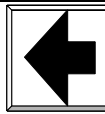
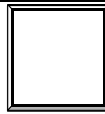

ASSY, BUTTON-UP, 3900GC GALILEO
BUTTON-UP STATION, ASSEMBLY PROCEDURES



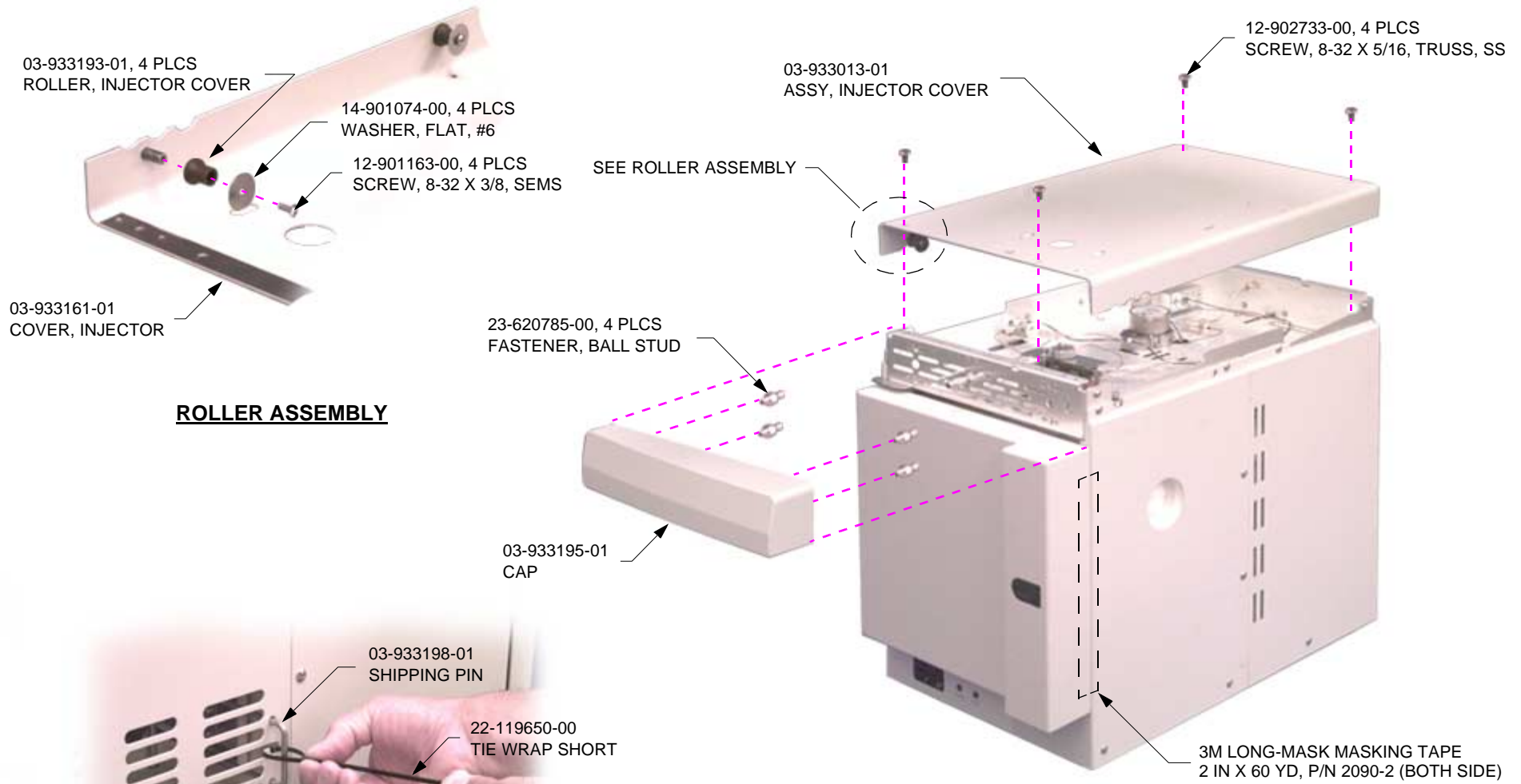
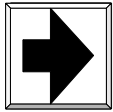
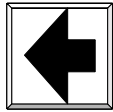

ROLLER ASSEMBLY

SHIPPING INSTALLATION (LEFT SIDE)

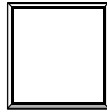

1. 3900GC GALILEO BUTTON-UP ASSEMBLY PROCEDURES

1.1 OPERATION IN SEQUENCE

- 1.1.1 Reference the 3900 Button-Up checklist and perform all appropriate tasks.
- 1.1.2 Assemble four each rollers, 03-933193-01 onto injector cover, 03-933161-01 using four each washers, 14-901074-00 and four each screws, 12-901163-00 as shown.
- 1.1.3 Install injector cover assembly, 03-933013-01 onto 3900. Verify injector cover rolls freely on chassis top and that 1177 injector aligns with hole in cover. Secure injector cover to GC using four each truss screws, 12-902733-00.
- 1.1.4 Install four each ball studs, 23-620295-00 onto cap, 03-933195-01. Install cap assembly onto 3900 to assure proper fit. Remove cap assembly, wrap and install into accessory box.
- 1.1.5 Install shipping pin, 03-933198-01 into the left side service cover and secure with tie wrap, 22-119650-00 as shown. **Note: Do not cut off excess end of tie wrap.**
- 1.1.6 Affix a 12" piece of masking tape, 3M part number 2090-2 on both sides of front door assembly and oven sides as shown.
- 1.1.7 Install 3900GC into shipping box, 03-933000-BX and place accessory kits, column box, line cord and cap as shown in shipping kit reference.



SHIPPING KITS (REF.)

VARIAN



CHG
HISTORY

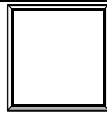

PARTS
LIST

MENU

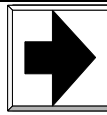
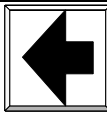

DOC: BUTTON-UP STATION

DESC: Assy, Button-Up, 3900GC Galileo

PAGE: 4 of 3

REV

1

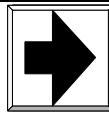
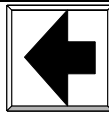

**ASSY, INSTL/KIT, GC/MS EFC POWER FAIL
3900GC STATION X, ASSEMBLY PROCEDURES**

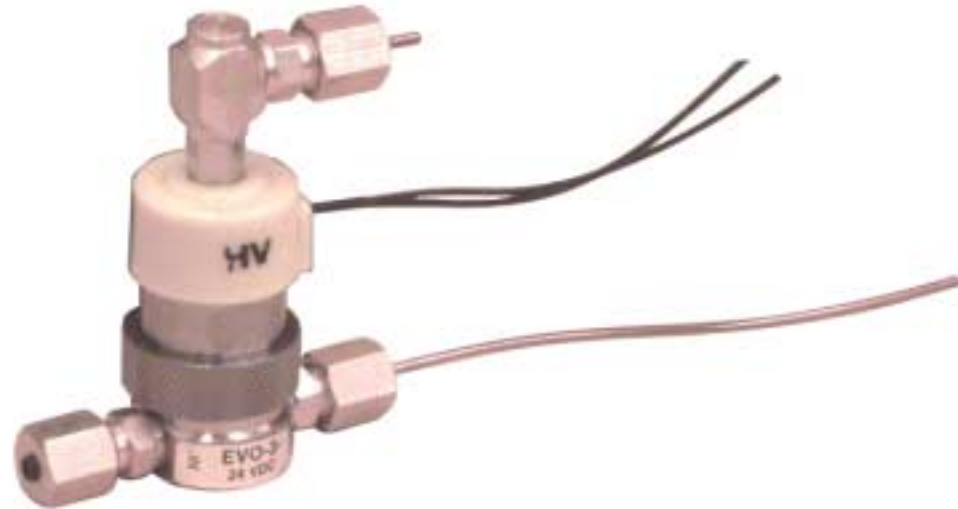

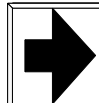
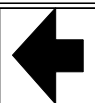

NOTES:

XX

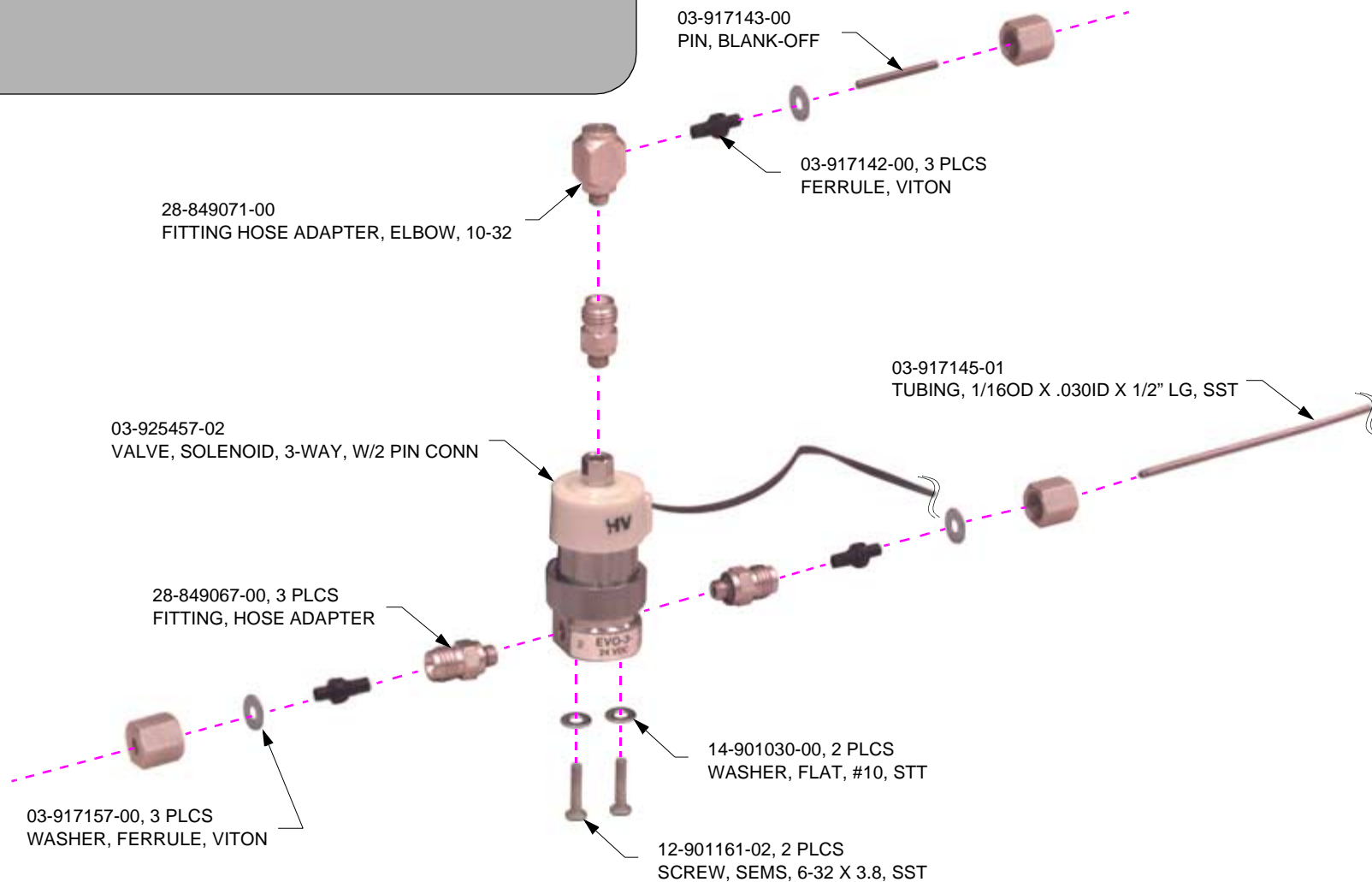

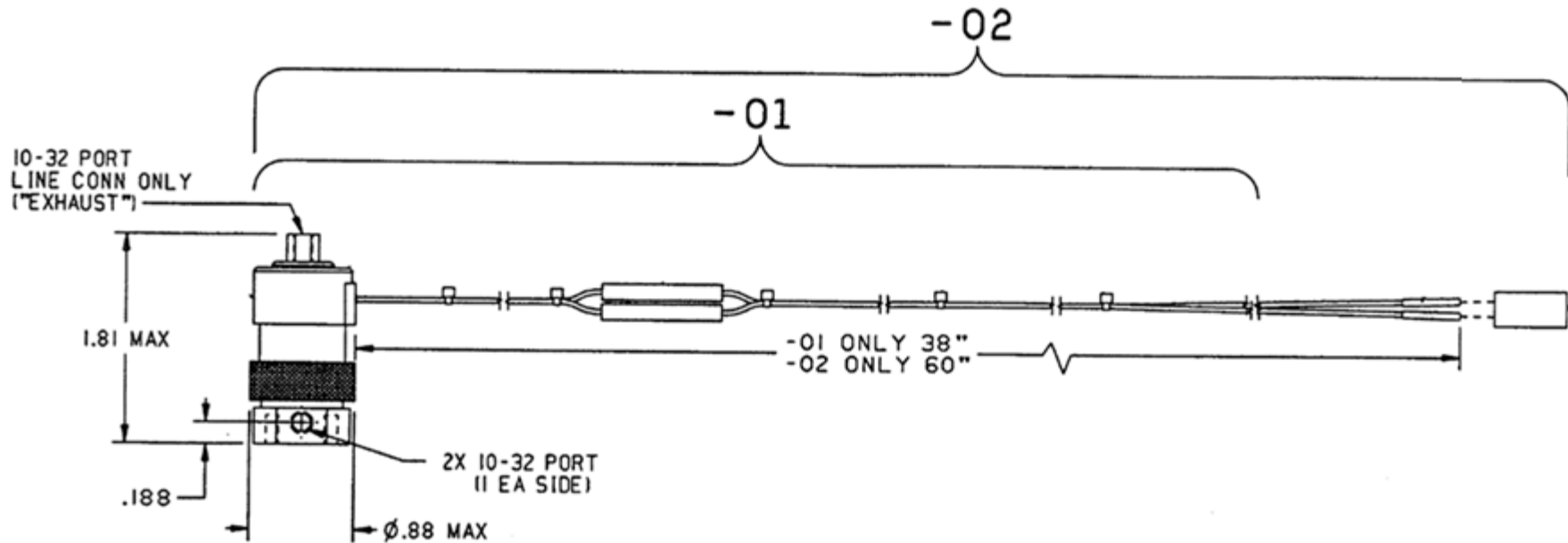
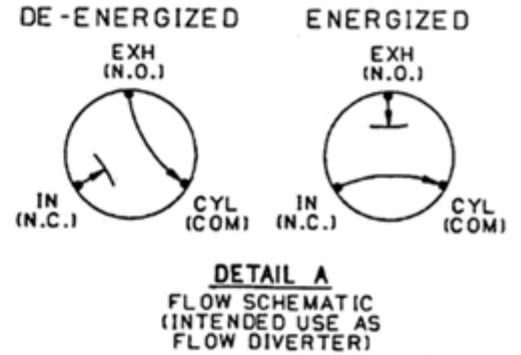
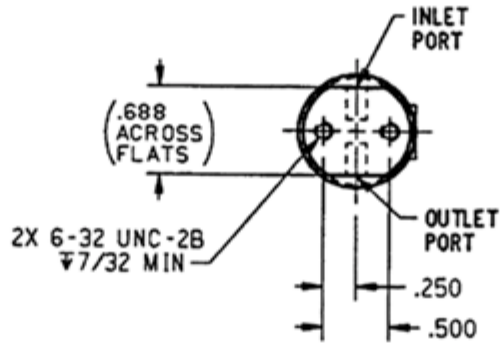
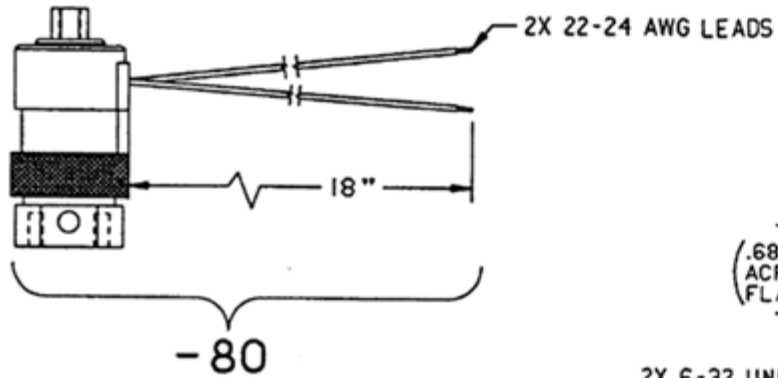
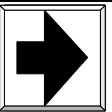
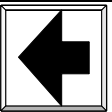

VARIAN



CHG
HISTORY

TOOLS

PARTS
LIST

MENU

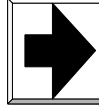

DOC: 03-925520-00

DESC: Assy, INSTL/Kit, GC/MS EFC Power Fail

PAGE: 4 of x

REV

Pr

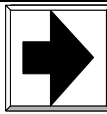
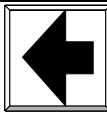
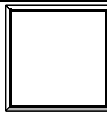
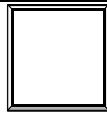

EFC SUB-ASSEMBLY, INSTALLATION
3900GC GALILEO STATION GC SUBS, ASSEMBLY PROCEDURES

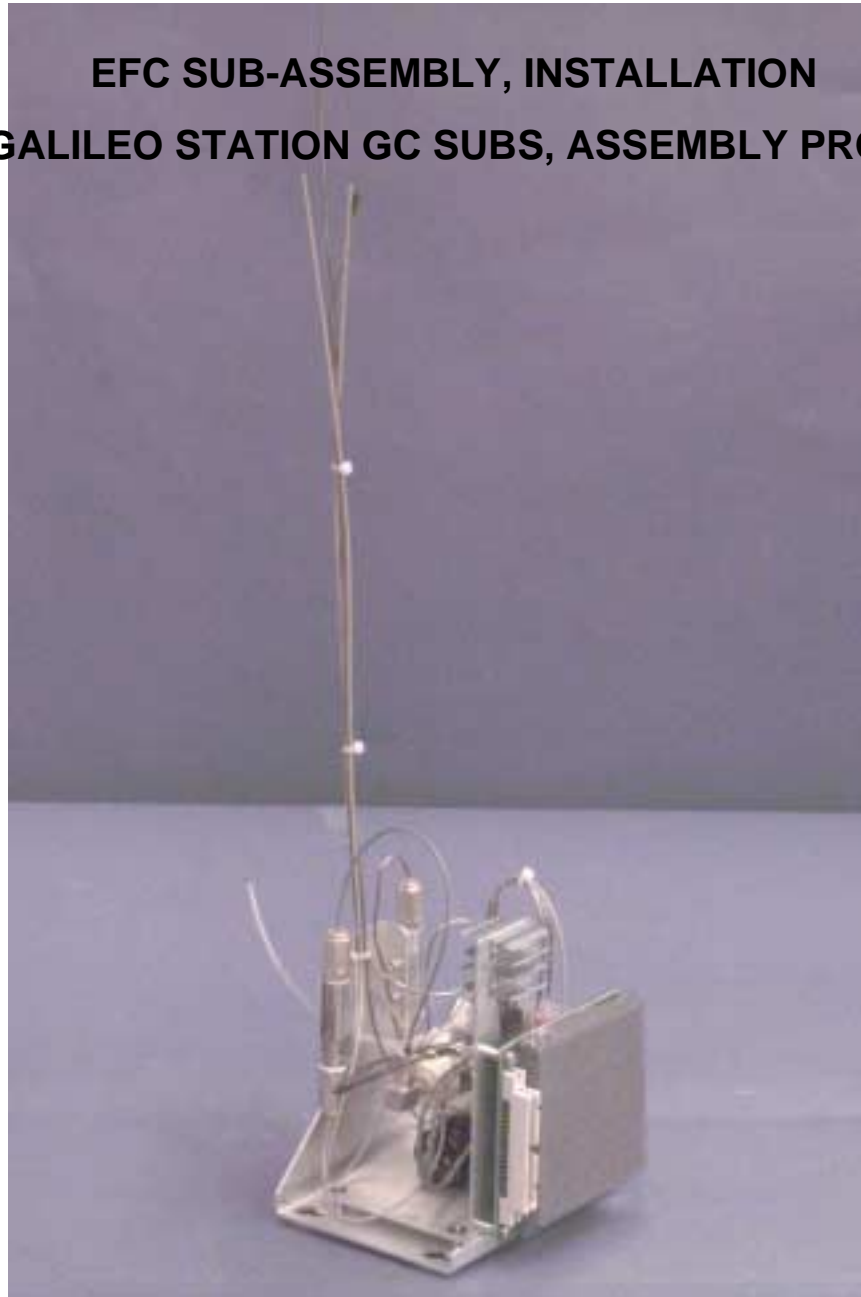

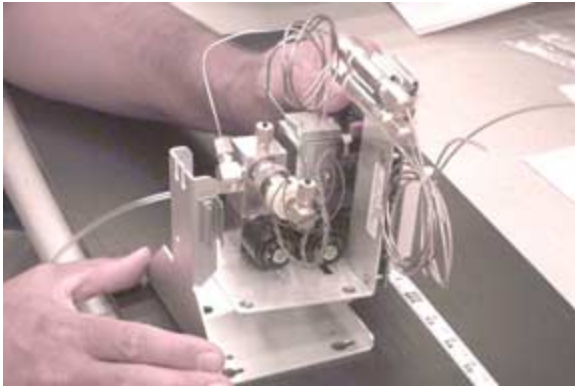

Figure 1

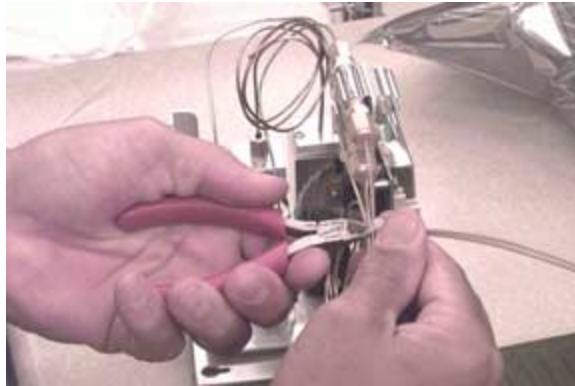

Figure 2



Figure 3



Figure 4

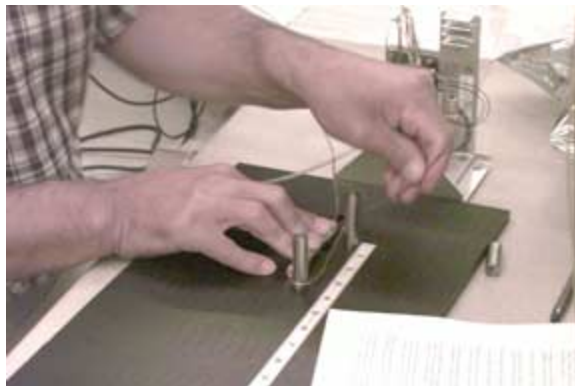
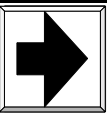
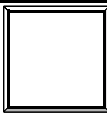
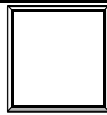

Figure 5



Figure 6



1. 3900GC EFC SUB- ASSEMBLY PROCEDURES

1.1 OPERATION IN SEQUENCE

- 1.1.1 Rivet two each filter spring clips, 03-949744-00 to EFC sub-plate, 03-933203-01 using four each rivets, 17-699907-00 not shown.
- 1.1.2 Mount the appropriate EFC, 03-925110-21 (Type 21) or 03-925110-25 (type 25) to EFC Sub-plate, 03-933203-01 with four each 8-32 X 1/4" screws, 12-901165-00 not shown.
- 1.1.3 Set the EFC assembly on the left side of fixture T#4386 not shown.
- 1.1.4 Carefully cut tie wrap securing tubes, unclip the filter that has green PEEK tubing and lay to side. For type 25 EFC's only, install a 22" piece of natural PEEK tubing, 03-925841-22 with a viton ferrule, 03-917142-00 and washer, 03-917157-00 to the empty end of filter as shown.
- 1.1.5 Unclip the carrier out filter and lay to side. Straighten tubing and place a green tube identifier, 03-918164-03 on end of SST tube.
- 1.1.6 Lay the carrier filter in the horizontal recess on the fixture as shown. Insert pin into hole labeled "Pin 1" on fixture and bend tubing, (while holding filter in place) counter clockwise until clear of hole labeled "Pin 2". See Figure 4.
- 1.1.7 Insert pin into hole labeled "Pin 2" and bend tubing clockwise until tube touches pin 1. See Figure 5.
- 1.1.8 Remove pins 1 and 2 and insert pin into hole labeled "Pin 3". Hold carrier filter on fixture as shown. While holding the tubing on pin 3, rotate filter 90° clockwise until it rests in the vertical recess on fixture. See Figure 6.
- 1.1.9 Slide the carrier tubing into middle of sub plate and clip filter into left clip as shown. Straighten SST carrier inlet tube so it protrudes straight up from sub-assembly. See Figure 7.
- 1.1.10 Snap the split flow filter onto right clip of sub-plate with green PEEK tubing on top as shown in Figure 8. NOTE: If required rotating the Clippard valve head is acceptable to reduce sharp bends in the PEEK tubing.
- 1.1.11 Form the carrier inlet tube to conform to the SST block jumper. Route the jumper tube, pressure sense line (yellow. Type 21 only) and SST carrier inlet tubes together at the top of jumper and secure with tie wrap, 22-119650-00 as shown in Figure 9,10 and 11.
- 1.1.12 Route all tubes up from the center of the sub-plate and loosely install tie wraps, 22-119650-00 at approximately 4" and 9" from top of plate as shown in Figure 12.



Figure 7

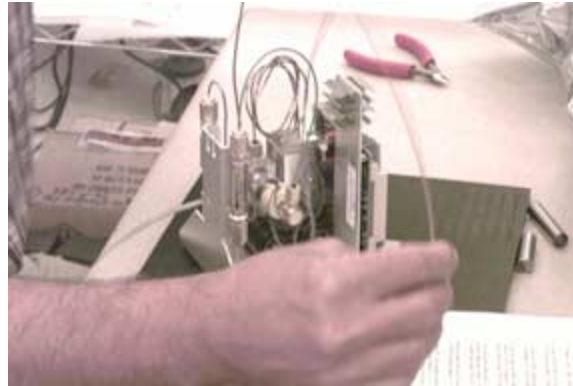

Figure 8

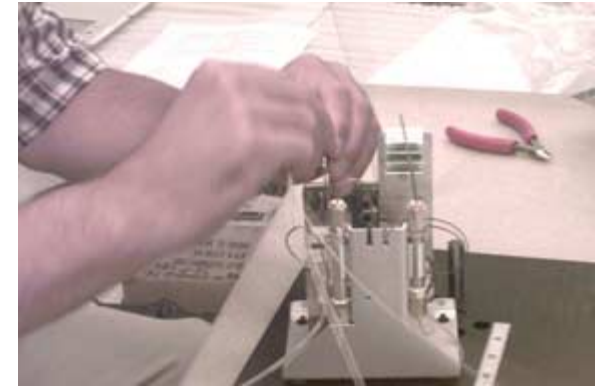

Figure 9



Figure 10

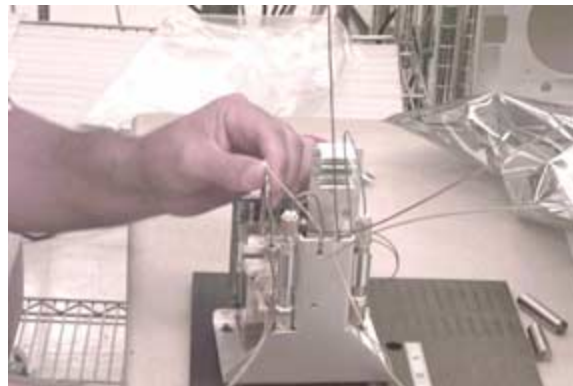

Figure 11

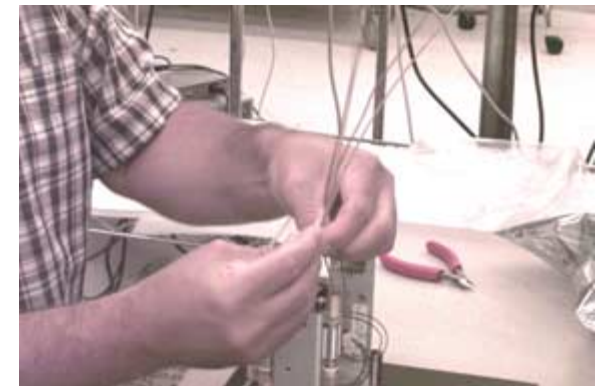

Figure 12

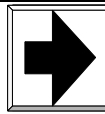
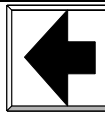
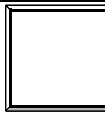
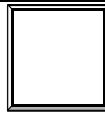

Figure 13

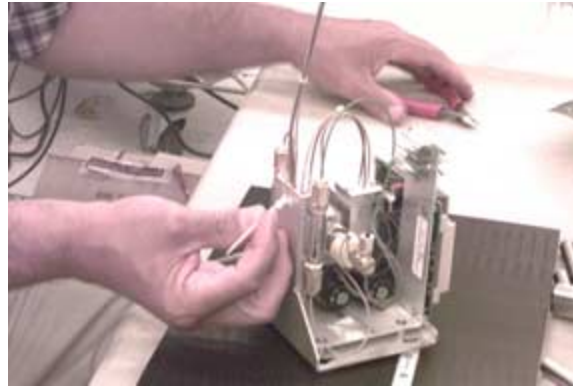

Figure 14

- 1.1.15 Lay the EFC sub-assembly down as shown in Figure 13 to measure and adjust tubing length. Adjust the SST tube that is not labeled to 16" +/- .25" and the other three tubes (two tubes for type 25) to 13" +/- .25". Tighten tie wrap to secure tubes.
- 1.1.16 Set the assembly upright and gather the four tubes and install a final tie wrap on the bracket as shown in Figure 14.
- 1.1.17 Route the clear vent tube through the obround hole in the bracket, leave approximately 6" of tubing protruding through bracket not shown.

VARIAN



CHG
HISTORY

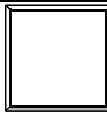
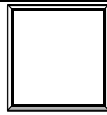

MENU

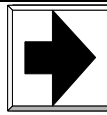
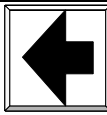

DOC: 03-933016-21/25

DESC: EFC Sub-Assembly, Installation

PAGE: 6 of 5

REV

1

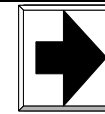
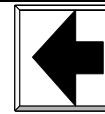
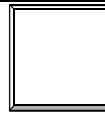

ASSY, HEATER 101V, 120V & 230V
3900GC STATION GC SUBS, ASSEMBLY PROCEDURES

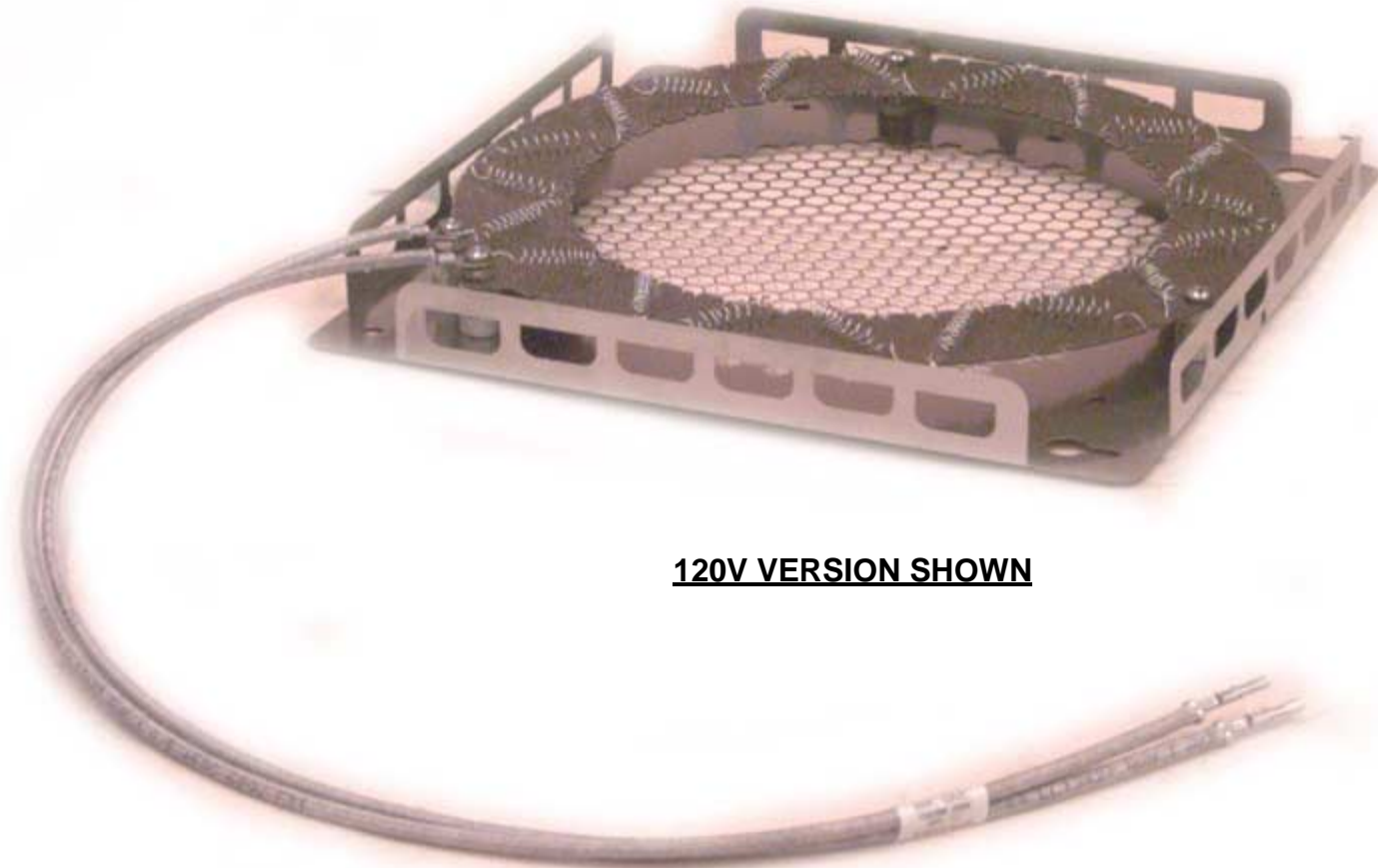

120V VERSION SHOWN

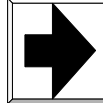
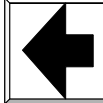

(REFERENCE 03-933005-00 DRAWING)

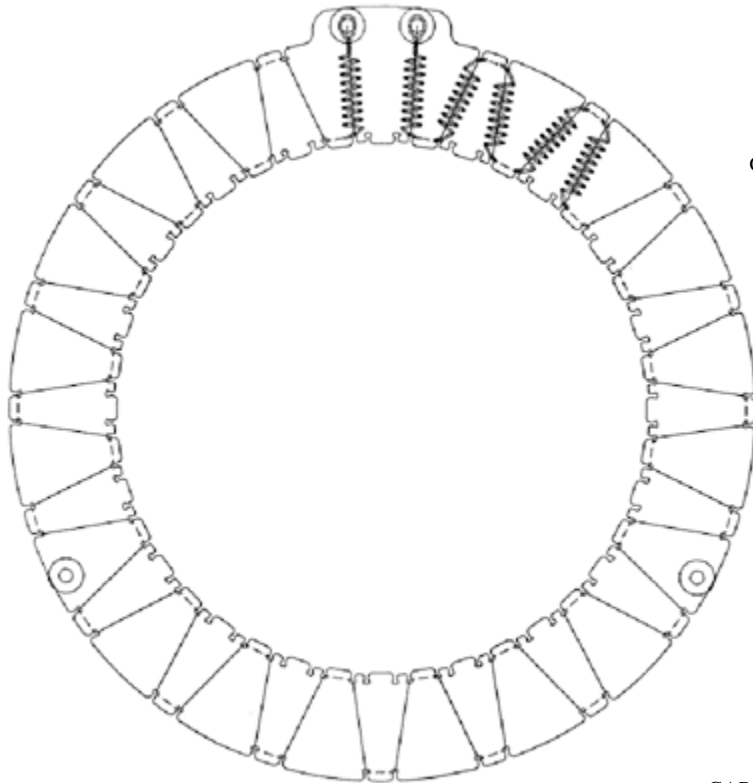

03-933005-02 (FIGURE 2)
CONFIGURATION

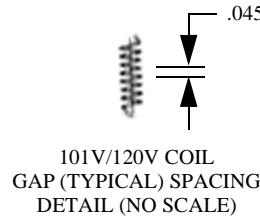

FIGURE 1

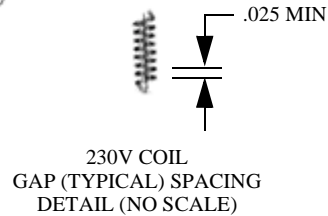
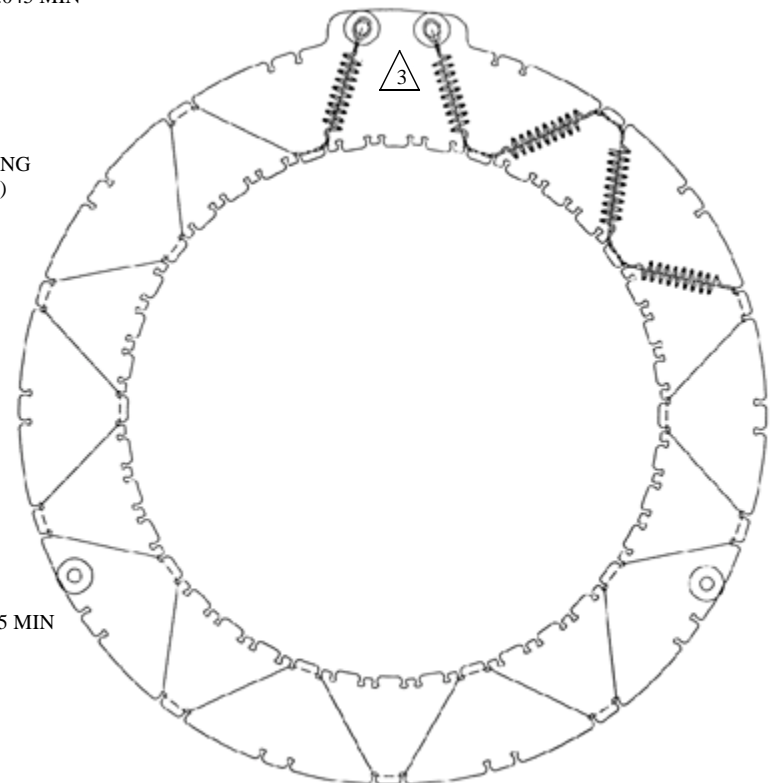



FIGURE 2



03-933005-01/03 (FIGURE 1)
CONFIGURATION

NOTES:

1. PRIOR TO ROUTING HEATERS (-01/-03) AS SHOWN, HOLD THE EYELET AT EACH END OF THE HEATER AND STRETCH TO OBTAIN A RELAXED LENGTH OF $24.0'' \pm .5$, SEE COIL IN FIGURE 1 FOR LOOP SPACING.
2. PRIOR TO ROUTING HEATERS (-02 ONLY) AS SHOWN, HOLD THE EYELET AT EACH END OF THE HEATER AND STRETCH TO OBTAIN A RELAXED LENGTH OF $40.0'' \pm .5$, SEE COIL IN FIGURE 2 FOR LOOP SPACING.

 FOR THE (-03 VERSION ONLY), USE BLACK PERMANENT INK TO MARK THE "101V" ON HEATER ELEMENT SUPPORT (03-933175-01) AS SHOWN ON DRAWING.

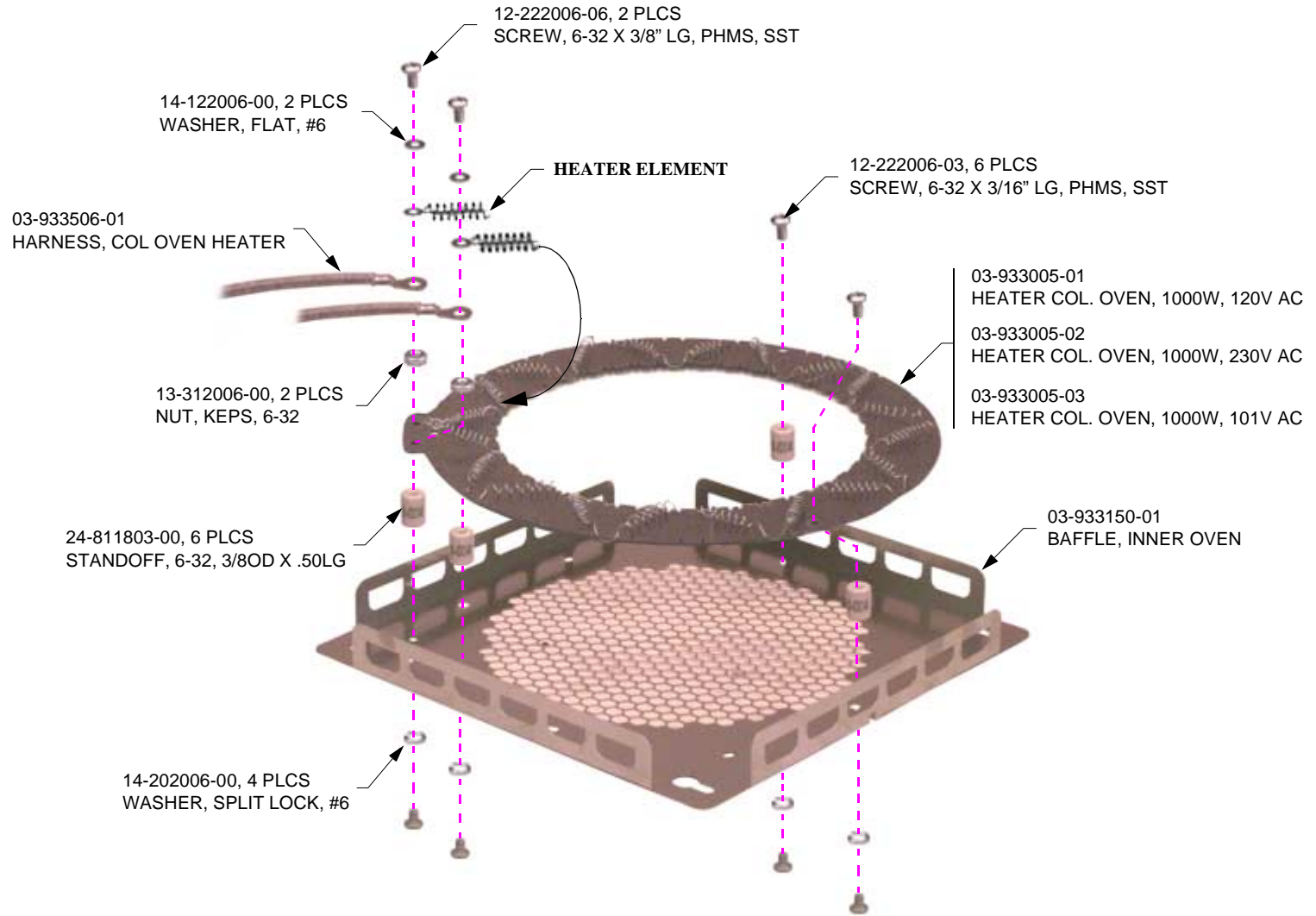
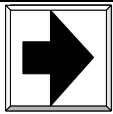
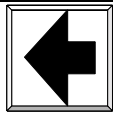

EXPLODED VIEW

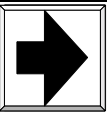

1. 3900 GALILEO, 101V, 120V & 230V HEATER ASSEMBLY PROCEDURES

1.1 OPERATION IN SEQUENCE

- 1.1.1 Build the appropriate heater element assembly, 03-933005-0X as detailed on drawing.
- 1.1.2 Insert one each 6-32 x 3/8" screw, 12-222006-06 with one each #6 flat washer, 14-122006-00 through one heater coil eyelet and one lug of heater harness, 03-933506-01. Tightly secure with one each 6-32 Kep nut, 13-312006-00 using a 5/16" nut driver and Phillips screw driver. Repeat this process for the other side of heater coil.
- 1.1.3 Position the remaining threads of the two each 6-32 X 3/8" screws through the mica heater element support ring and secure (FINGER TIGHT) using two each ceramic standoffs, 24-811803-00. Obtain two more ceramic standoffs and secure to heater element support ring using two each 6-32 X 3/16" screws, 12-222006-03 as shown.
- 1.1.4 Install heater element support ring assembly to inner over baffle, 03-933150-01 using four each #6 split lock washers, 14-202006-00 and four each 6-32 X 3/16" screws, 12-222006-03 as shown.

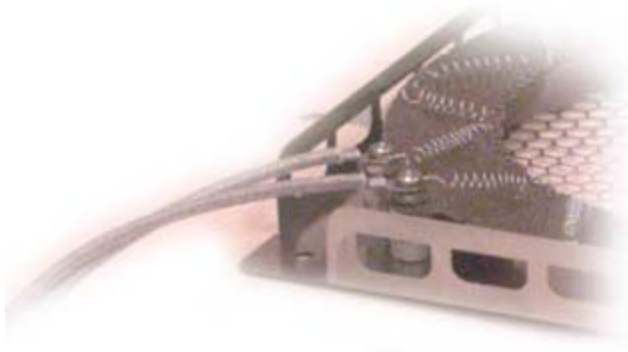

ASSEMBLY DETAIL (REF.)

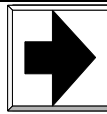
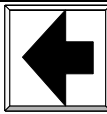
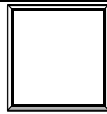

**ASSY, COLUMN OVEN MOTOR
SUB-ASSEMBLIES STATION, ASSEMBLY PROCEDURES**



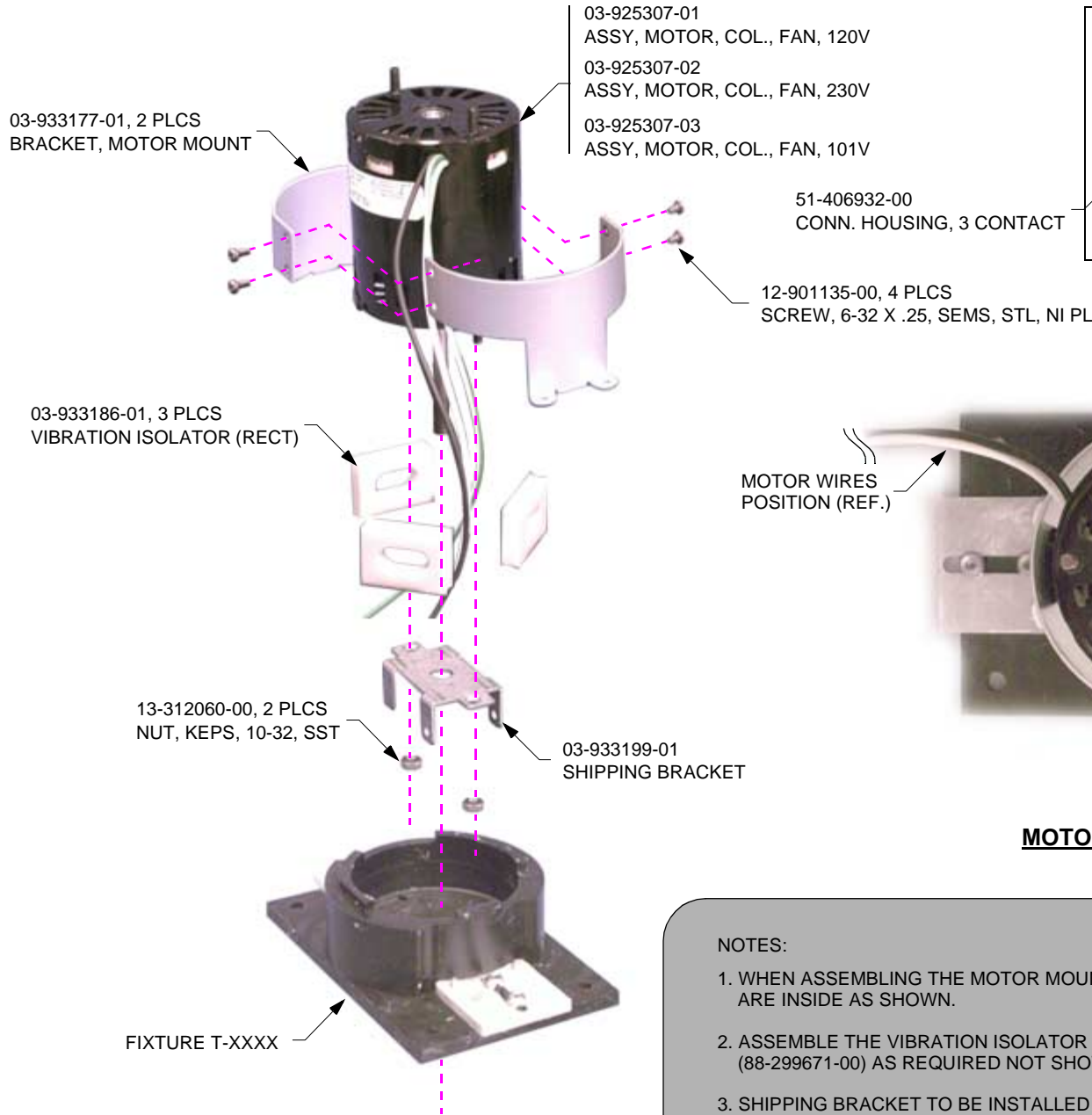
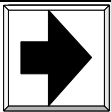
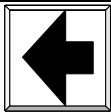

| | PIN NUMBER | WIRE COLOR |
|--|------------|------------|
| | 1 | GRN/YEL |
| | 2 | WHT |
| | 3 | BLK |

CONNECTOR WIRING TABLE

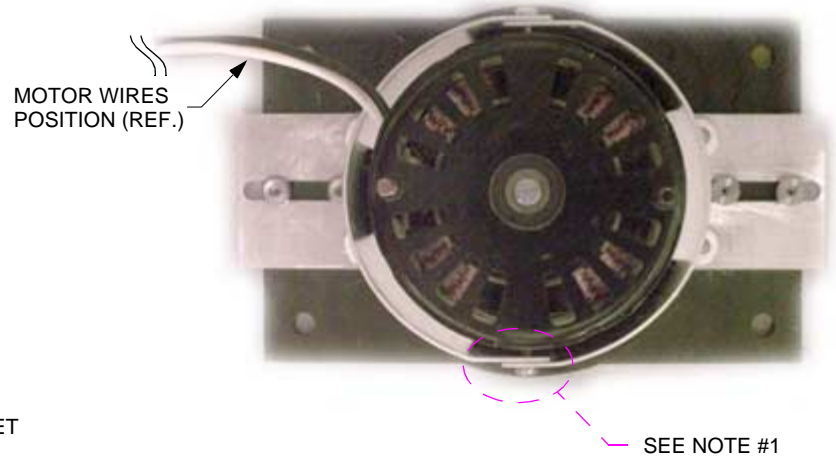

MOTOR ASSEMBLY TOP VIEW

EXPLODED VIEW

NOTES:

1. WHEN ASSEMBLING THE MOTOR MOUNT BRACKETS, MAKE SURE THE THREADED HOLES ARE INSIDE AS SHOWN.
2. ASSEMBLE THE VIBRATION ISOLATOR IN ARRANGEMENT SHOWN, USING DC #732 RTV ADHESIVE (88-299671-00) AS REQUIRED NOT SHOWN AND WIPE OFF ANY EXCESS.
3. SHIPPING BRACKET TO BE INSTALLED LAST, AFTER MOTOR ASSEMBLY HAS DRIED OVER NIGHT.

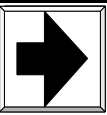
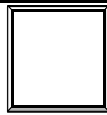

1. COLUMN OVEN MOTOR ASSEMBLY PROCEDURES

1.1 OPERATION IN SEQUENCE - Note: This operation should be performed in a well ventilated area and assembler should wear rubber gloves.

- 1.1.1 Prior to assembly, clean Column Oven Motor and Motor Mount Brackets with IPA.
- 1.1.2 Obtain proper Column Oven Motor, 03-925307-0X depending on application, place motor shaft into center hole of the Fixture T-8981 and position the wires toward the left with two cutout toward you as shown in motor assembly top view.
- 1.1.3 Apply a thin coating of DC #732 RTV Adhesive, 88-299671-00 on the motor where the rectangular cut-outs on fixture are located. Place three each Vibration Isolator, 03-933186-01 onto motor. Using the cut-outs in fixture for proper orientation. Make sure isolator is completely coated with RTV.
- 1.1.4 Apply a thin coating of DC #732 RTV Adhesive inside both Motor Brackets, 03-933177-01. Assemble Motor Brackets onto the fixture stud mount, make sure Isolators are properly aligned prior to securing with four 6-32 x 1/4 Sems Screws, 12-901135-00 as shown.
- 1.1.5 Obtain Connector Housing, 51-406932-00 and referring to CONNECTOR WIRING TABLE on page #2, install motor pins into connector. **Note:** marking on connector for proper pin numbers.
- 1.1.6 Leave the Column Oven Motor Assembly on the fixture and move to wire rack for drying. Remove the Column Oven Motor Assembly from the fixture after drying overnight and secure Shipping Bracket, 03-933199-01 using two 10-32 Keps Nuts, 13-3120060-00 as shown.

VARIAN



CHG
HISTORY

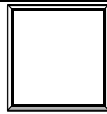

PARTS
LIST

MENU

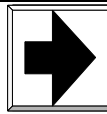
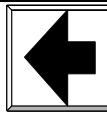

DOC: 03-933012-00

DESC: Assy, Column Oven Motor

PAGE: 4 of 3

REV

1



CHG
HISTORY

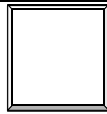

PARTS
LIST

MENU

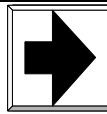
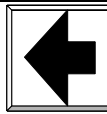

ASSY, FRONT DOOR
3900GC STATION GC SUBS, ASSEMBLY PROCEDURES



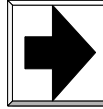
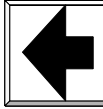

FRONT DOOR (REF.)

03-933186-03
VIBRATION ISOLATOR (OBROUND)

SEE EXPLODED VIEW BELOW

12-901165-00, 4 PLCS
SCREW, 8-32 X 1/4 SEMS, SST

BRACKET INSTALLATION

71-300053-00
SENSOR, MAGNETIC PROXIMITY, ACTUATOR

R0-028000-55, 2 PLCS
STANDOFF, 4-40 X 1/4", HEX

MAGNETIC SENSOR INSTALLATION

03-933157-00
STRIKE PLATE

03-933159-01
LATCH RELEASE

19-224776-00, 2 PLCS
ROLL PIN, .094OD X .38 LG

14-999408-00, 2 PLCS
WASHER, FLAT .093ID X .312 X .01, TEFLON

BRACKET ASSEMBLY

03-933011-01
ASSY, COLUMN OVEN DOOR

03-933160-01, 2 PLCS
SPRING, OVEN DOOR

17-699907-00, 4 PLCS
RIVET, BLIND, DIA. 1/8 X .265, AL

03-933156-01
DOOR, FRONT, GC

21-139978-00, 2 PLCS
BEARING, NYLON SLEEVE, SNAP IN, 1/8" SHAFT

COLUMN OVEN DOOR ASSEMBLY INSTALLATION

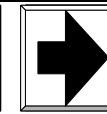
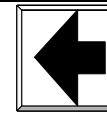
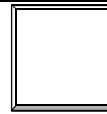

1. FRONT DOOR ASSEMBLY PROCEDURES

1.1 BRACKET ASSEMBLY

- 1.1.1 Install two Roll Pins, 19-224776-00 on both sides of the Latch Release, 03-933159-01 using Press Tool until pins bottoms out.
- 1.1.2 Install two Teflon Flat Washers, 14-999408-00 onto the Roll Pins previous installed and install Strike Plate, 03-933157-00 onto roll pins as shown. It is OK to flex Strike Plate slightly during this installation. Do not permanently distart strike plate!

1.2 STRIKE PLATE ASSEMBLY INSTALLATION

- 1.2.1 Install the *obround* Vibration Isolator, 03-933186-03 approximately 3/4" from the top of the Latch Release using Double Side Tape, DY-700098-00. Excess tape can be trimmed with an exacto knife.
- 1.2.2 Secure the Strike Plate Assembly onto the GC Front Door, 03-933156-01 using four 8-32 x 1/4 Sems Screws, 12-901165-00 as shown. Check that latch release operates smoothly and does not scrape against front door opening.

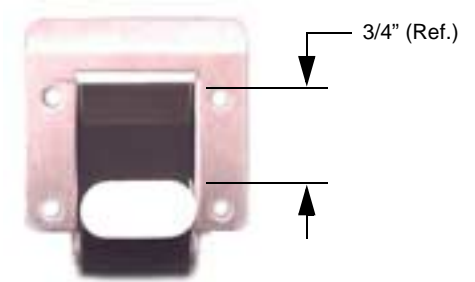

ISOLATOR INSTALLATION (REF.)

1.3 MAGNETIC SENSOR INSTALLATION

- 1.3.1 Using a 3/16" nut driver, install Actuator Magnetic Proximity Sensor, 71-300053-00 onto the front door, using two 4-40 x 1/4" Hex Standoffs, R0-08000-55 as shown.

1.4 COLUMN OVEN DOOR ASSEMBLY INSTALLATION

- 1.4.1 Install two each Oven Door Springs, 03-933160-01 onto the column oven door assembly using four each Blind Rivets, 17-699907-00 two each as shown.
- 1.4.2 Place one end of the oven door spring on the stud mounts of the front door. Flex on opposite ends of the oven door spring with your fingers and place the oven door spring onto the other two stud mounts.
- 1.4.3 Install two 1/8" Snap In Nylon Sleeve Bearings, 21-139978-00 into a holes on the end of the oven door where shown.

VARIAN



CHG
HISTORY

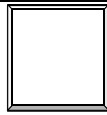

PARTS
LIST

MENU

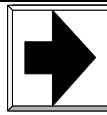
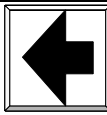

DOC: 03-933008-00

DESC: Assy, Front Door

PAGE: 4 of 3

REV

1



CHG
HISTORY

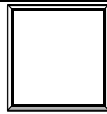

PARTS
LIST

MENU

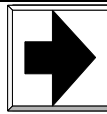
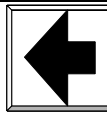

ASSY, VENT DOOR
3900GC STATION GC SUBS, ASSEMBLY PROCEDURES

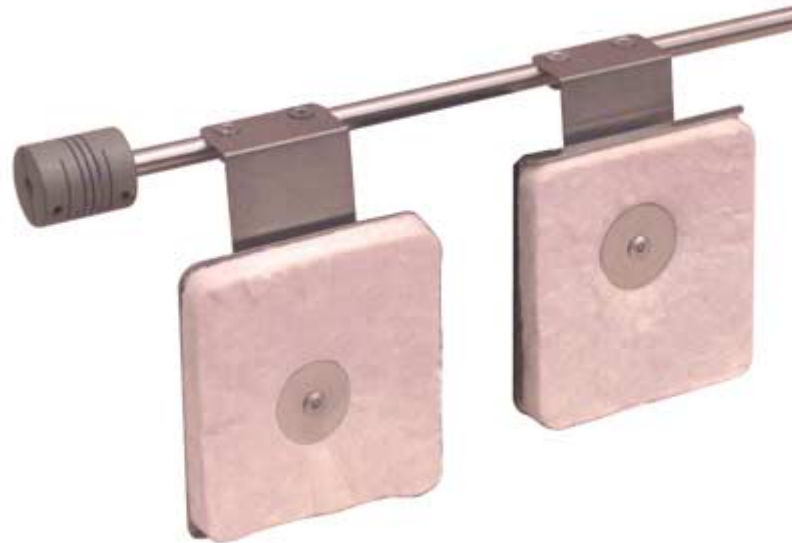

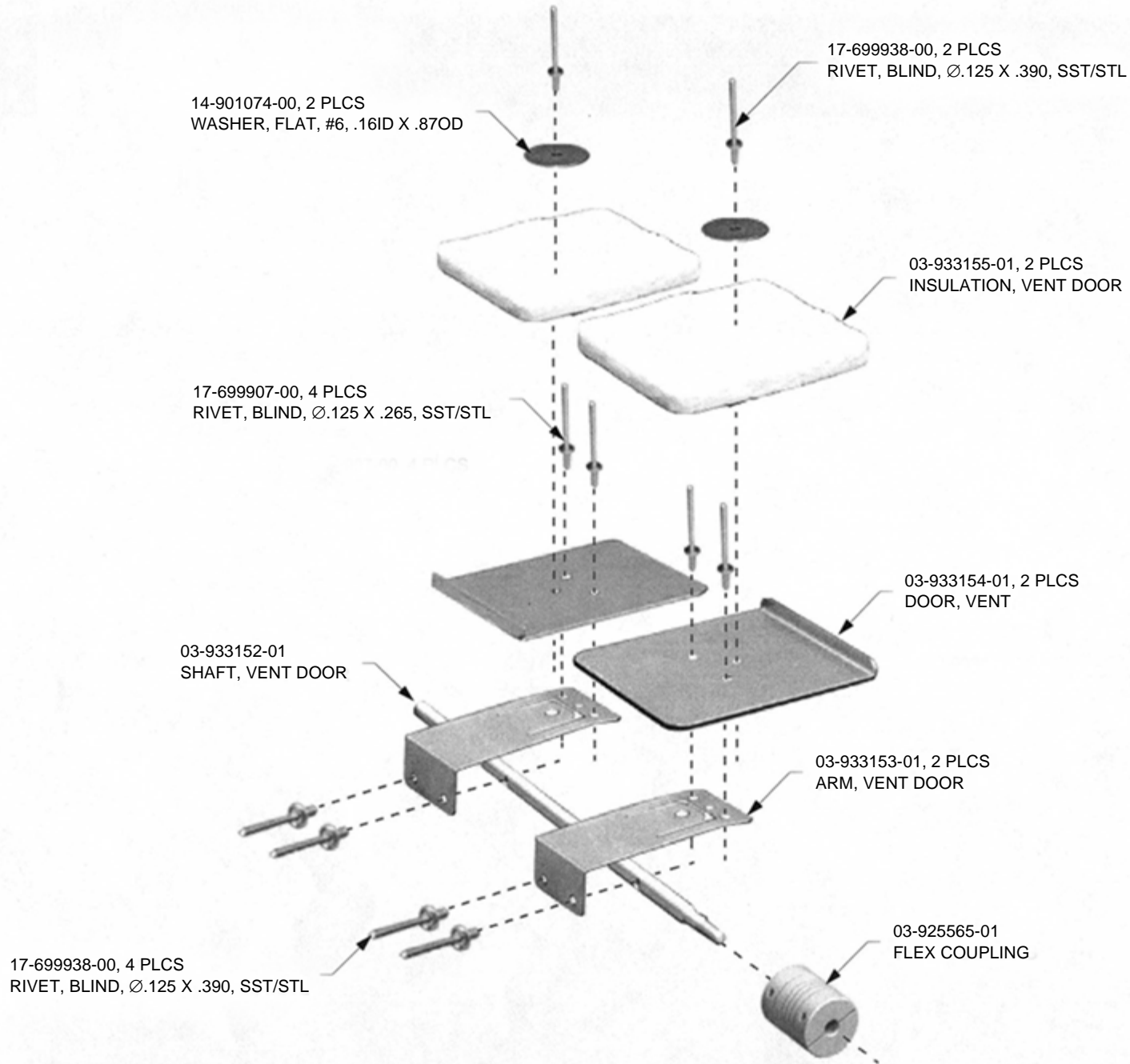
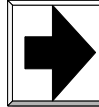



1. VENT DOOR ASSEMBLY PROCEDURES

1.1 OPERATION IN SQUENCE

- 1.1.1 Place the Vent Door Shaft, 03-933152-01 *with stepped end of shaft opposite the end plate* on Fixture T-8982 and align the holes on the shaft with the holes on the fixtures.
- 1.1.2 Place two Vent Door Arms, 03-933153-01 on the fixture with the flange down and align holes with shaft holes. Secure the vent door arms to shaft, using four each SST/STL Blind Rivets, 17-99938-00 and rivet gun as shown.
- 1.1.3 Rivet Vent Doors, 03-933154-01 onto vent door arms, using four each **Alumnium** Blind Rivets, 17-699907-00 from the top down. Make sure the vent door flanges are properly oriented onto fixture as shown.
- 1.1.4 Install Vent Door Insulation, 03-933155-01 using one Flat Washer, 14-901074-00 and one SST/STL Blind Rivets, 17-99938-00 as shown.
- 1.1.5 Install second vent door insulation, as described in previous step.
- 1.1.6 Remove the Vent Door Assembly from the fixture and using a 3/32" Allen Wrench install Flex Coupling, 03-925565-01 onto the stepped end of the vent door shaft as shown in Figure 2. Tighten coupling screw to 8-9 inch-lbs torque.

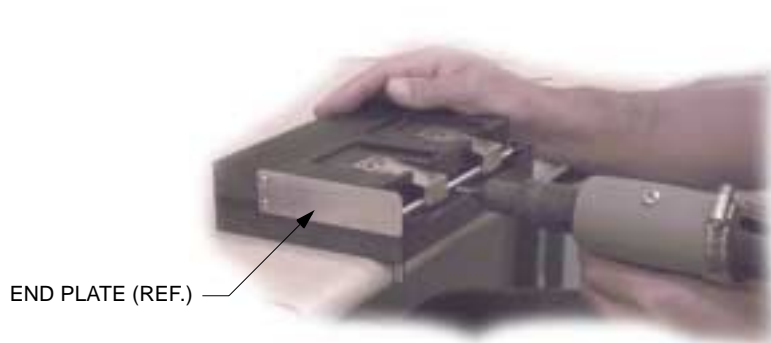

FIGURE 1

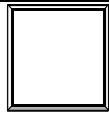

FIGURE 2

VARIAN



CHG
HISTORY



PARTS
LIST

MENU

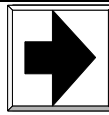
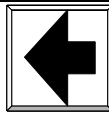

DOC: 03-933007-00

DESC: Assy, Vent Door

PAGE: 4 of 3

REV

1

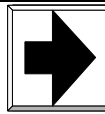
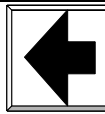
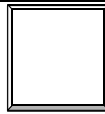

ASSY, ELECTRONIC MODULE

3900GC STATION GC SUBS, ASSEMBLY PROCEDURES



FAN CONNECTOR
REFERENCE J20 STEP 1.1.3

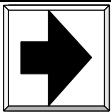
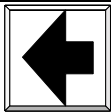

03-910873-01
COMPUTER, PROGRAMMED, 3900 MB



TOP VIEW (REF.)

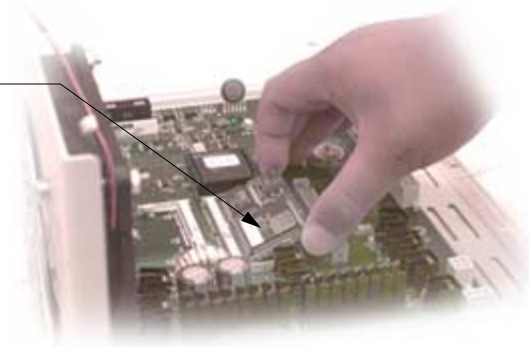

INSTALLATION DETAILS

12-222008-24, 4 PLCS
SCREW, 8-32 X 1-1/2" LG, PHMS, SST

20-839825-00
FINGER GUARD, FAN

03-925305-01
ASSY, CHASSIS FAN

13-312008-00, 4 PLCS
KEP NUT, EXT TH LOCK, 8-32

14-901074-00
WASHER, .16ID X .87OD X .03 THK, SST

12-222006-04, 8 PLCS
SCREW, 6-32 X 1/4" LG, PHMS, SST

03-933350-01
ASSY, PWA, MAIN BOARD

03-933171-01
COVER, RIGHT SIDE SERVICE

AIR FLOW DIR.

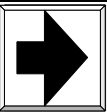
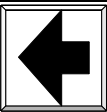
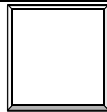

1. ELECTRONICS MODULE ASSEMBLY PROCEDURES

1.1 OPERATION IN SQUENCE

51-959920-00, 4 PLCS
 FEMALE SCREW LOCK SET, 4-40 X .31

1.1.1 Install Chassis Fan Assembly, 03-925305-01 onto Right Side Service Cover, 03-933171-01, using Fan Finger Guard, 20-839825-00, four 8-32 x 1-3/8" Lg PHMS Screws, 12-222008-24 and four 8-32 Ext TH Lock Kep Nuts, 13-312008-00 as shown. Make sure the arrows printed on the Chassis Fan Assembly are as shown in reference. Also make sure Fan Finger Guard orientation is as shown in Rear Panel Reference View.

Caution: Assembler should be properly grounded with anti-static protection when performing following steps.

1.1.2 Install Main Board PWA Assembly, 03-933350-01, to Right Service Cover, 03-933171-01, using seven 6-32 x 1/4" LG, PHMS Screws, 12-222006-04 and four each Lock Set Screws, 51-959920-00.

1.1.3 Attach Connector from the Chassis Fan Assembly to (J-20 Connector) on the Main Board PWA. See Cover sheet on page 1 for detail.

1.1.4 Install one Washer, 14-901074-00 onto the extruded stud mount on the Right Side Service Cover, using one each 6-32 x 1/4" LG, PHMS Screw, 12-222006-04 as shown.

1.1.5 Snap 3900MB Programmed Computer, 03-910873-01 into the Main Board PWA Assembly connector J8, as shown.



REAR PANEL REFERENCE

VARIAN



CHG
HISTORY

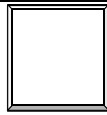

PARTS
LIST

MENU

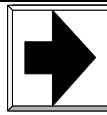
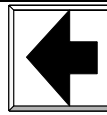

DOC: 03-933006-00

DESC: Assy, Electronics Module

PAGE: 4 of 3

REV

1

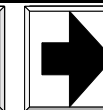
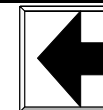
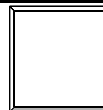

1. 3900GC GALILEO HY-POT, 3900 CONNECTION, ESTABLISH COMMUNICATIONS, LEAK TEST AND FUNCTIONAL TEST

Note: While using the computer, the term "click" refers to using the mouse to position the pointer to the required location and pushing the left mouse button.

Note: If the instrument fails to meet the required specifications, troubleshoot accordingly or contact a manufacturing engineer for assistance.

1.1 HY-POT

Warning:Never touch the instrument during hy-pot test!

Warning:Take any necessary precautions needed to keep area around instrument safe during testing!

- 1.1.1 Attach Hy-Pot ground and Instrument power cables to the 3900.
- 1.1.2 Connect 24Vdc connector to J12 and listen for click as contactor energizes.
- 1.1.3 Turn on 3900 Power switch.
- 1.1.4 Turn on Hy-Pot power switch.
- 1.1.5 Depress PUSH TO TEST key on Hy-Pot tester.
- 1.1.6 Observe Pass/Fail condition on Hy-Pot tester and assure voltage rises to between 1350 and 1400 volts. If the voltage is not correct adjust the voltage accordingly and retest.
- 1.1.7 Turn off Hy-Pot and instrument power switches.
- 1.1.8 Remove 24Vdc, Hy-Pot power and ground cables from the instrument.
- 1.1.9 Sign off Data Record under Hy-Pot.

1.2 3900 CONNECTION

- 1.2.1 Cap off injector column fitting and septum purge line, make sure septum nut and septum are installed.
- 1.2.2 With the power switch in the off position, connect appropriate line power and computer cable to 3900.
- 1.2.3 Connect helium line to 3900. Turn on helium.



1.3 ESTABLISH COMMUNICATIONS

1.3.1 Turn on the computer. After booting up, the Star Toolbar should be visible on the screen.

CLICK HERE
STEP 1.3.2

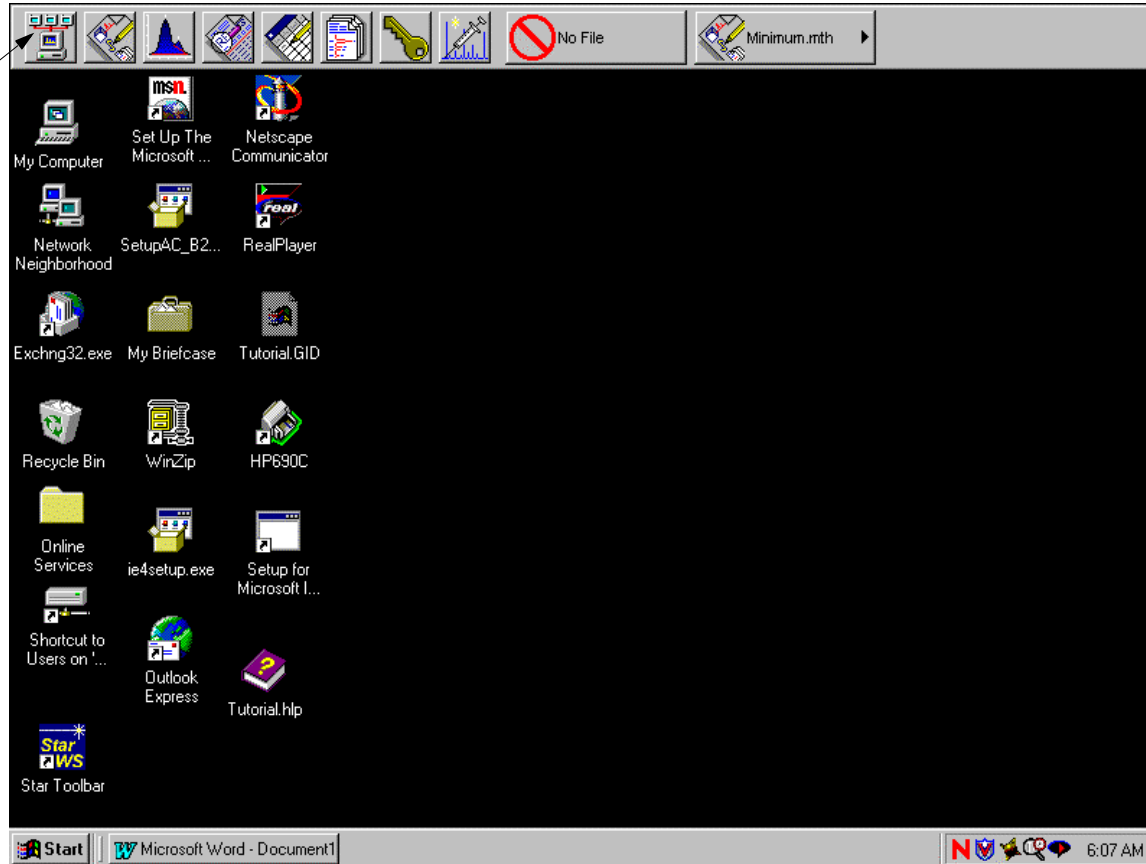

1.3.2 Click on the System Control/Automation



button.

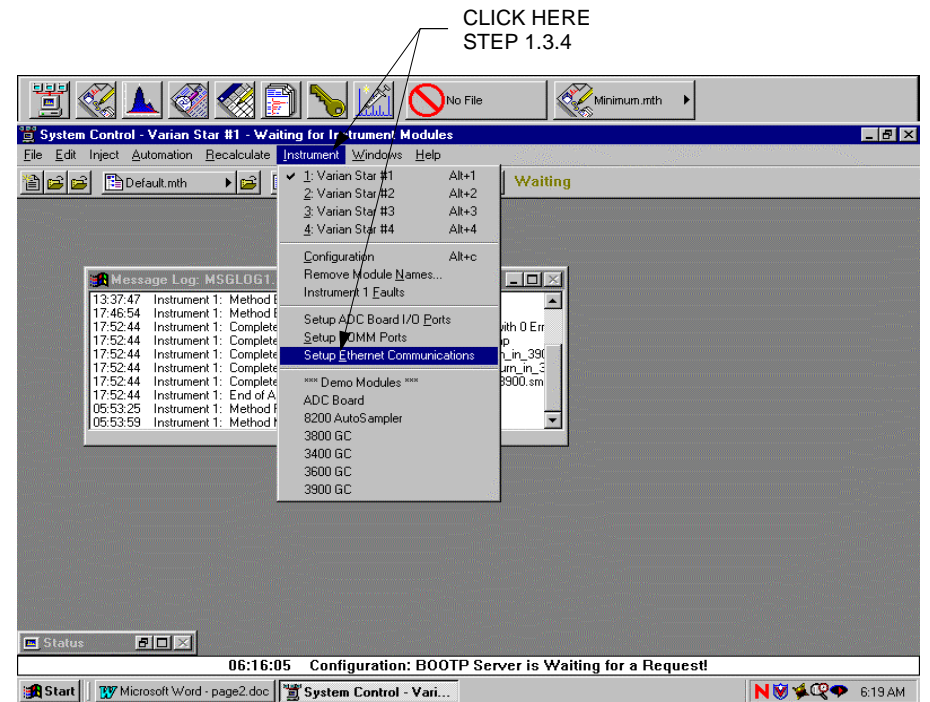
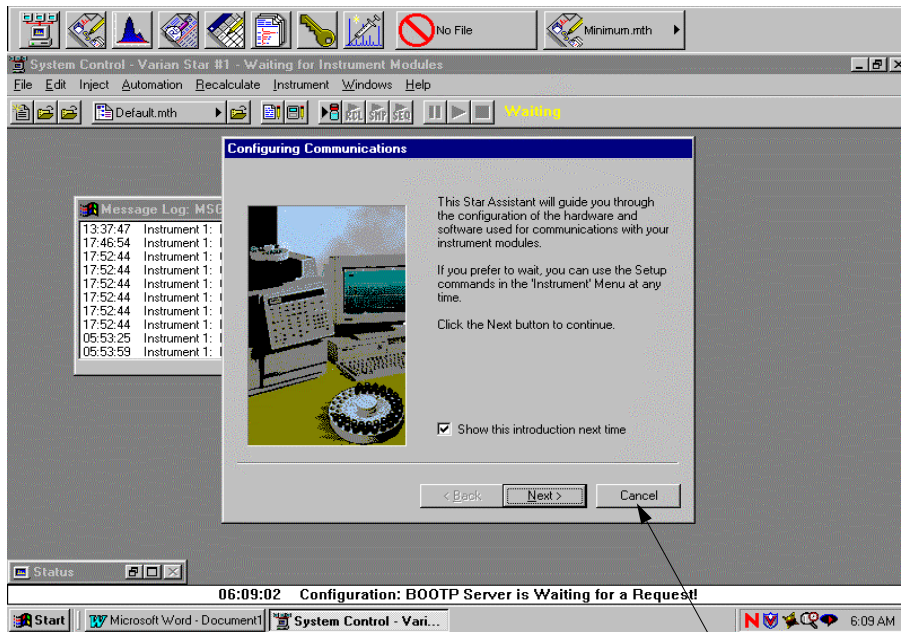
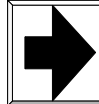

1.3.3 Click on the **Cancel** button.

1.3.4 To establish communications between the computer and the 3900GC, click on the **Instrument** menu. Then click the **Setup Ethernet Communications** item.

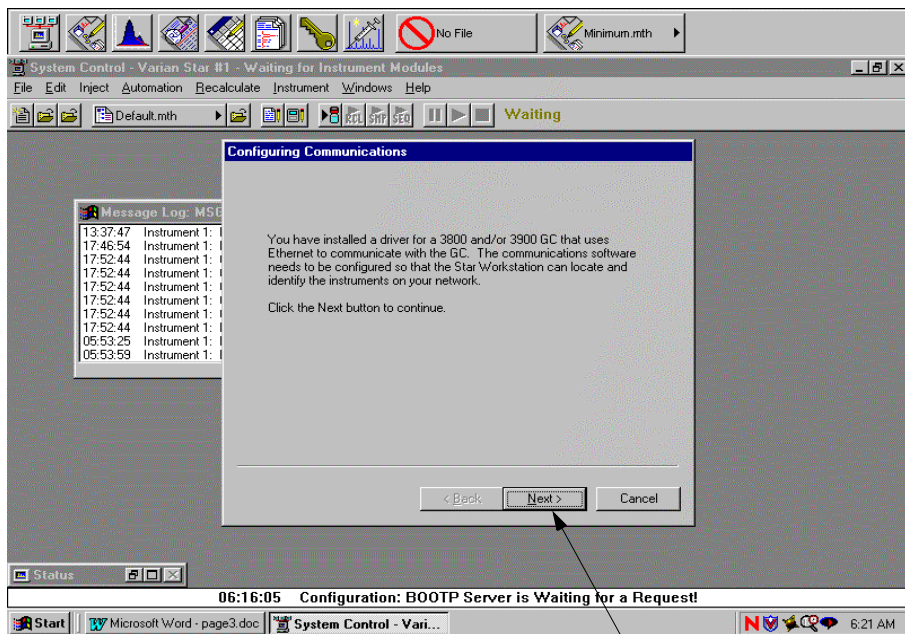
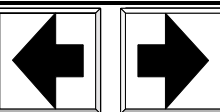

CLICK HERE
STEP 1.3.5

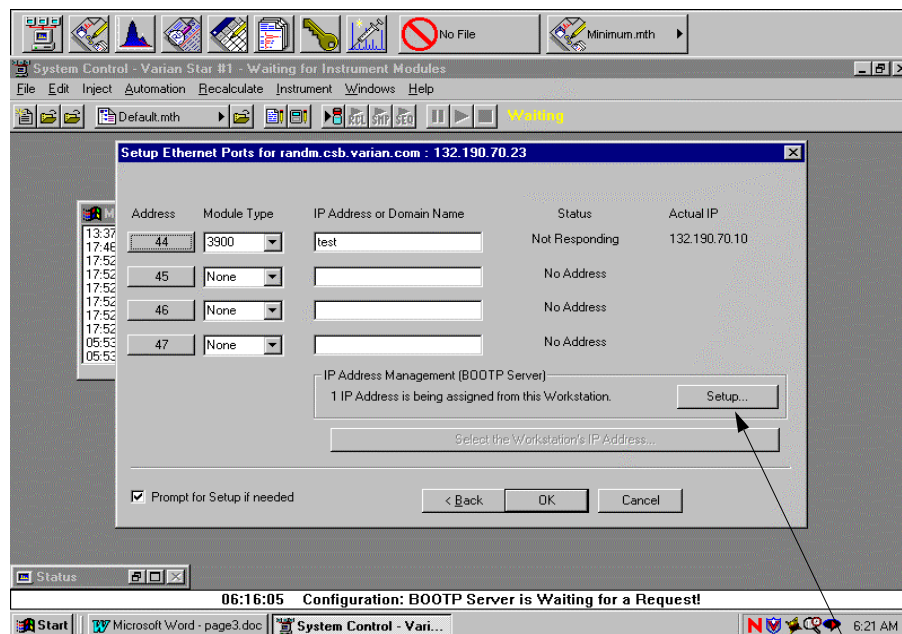

CLICK HERE
STEP 1.3.6

1.3.5 Click the  button.

1.3.6 Click the  button.

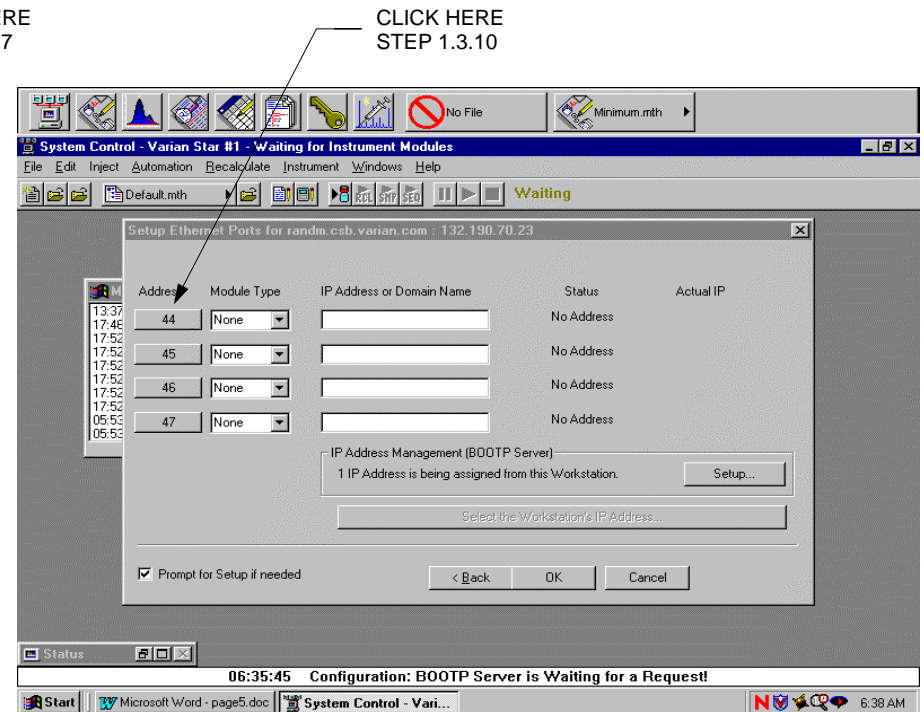
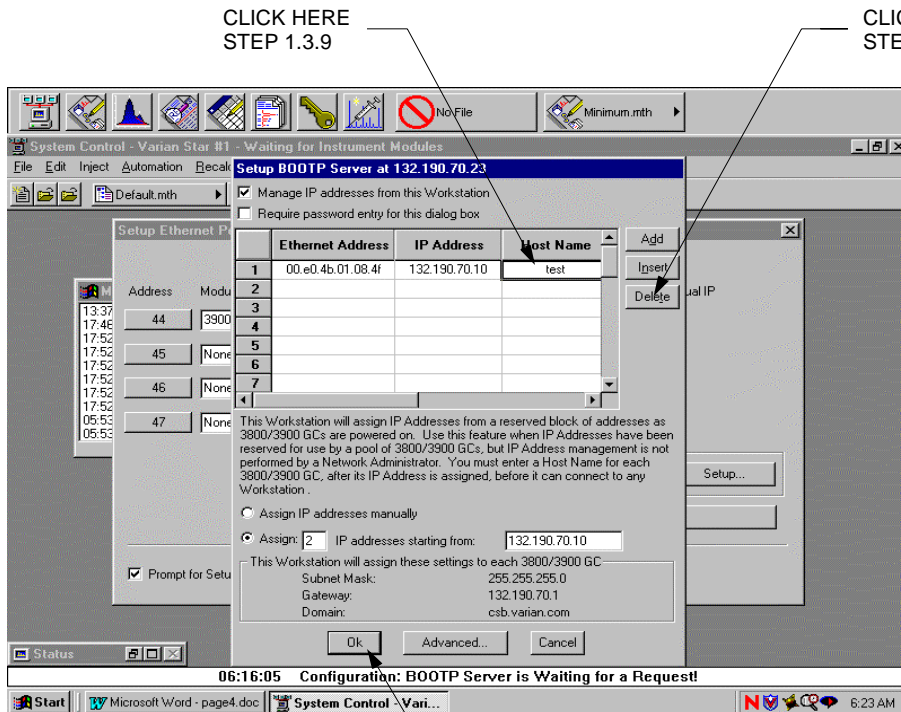

CLICK HERE STEP 1.3.9

1.3.7 Turn the 3900 power switch on.

1.3.8 If the last 4 digits of the serial number, of the 3900 being tested, are already in the Host Name block, skip the next step.

1.3.9 After new data appears on a line in the table, click the box under **Host Name** and replace <unnamed> with the last 4 digits of the 3900 serial number and push enter on the keyboard. Delete any extra lines of data in the table. This is done by clicking a box with data in it, and then clicking delete. Next, click **Ok**.

1.3.10 Click the **44** button.

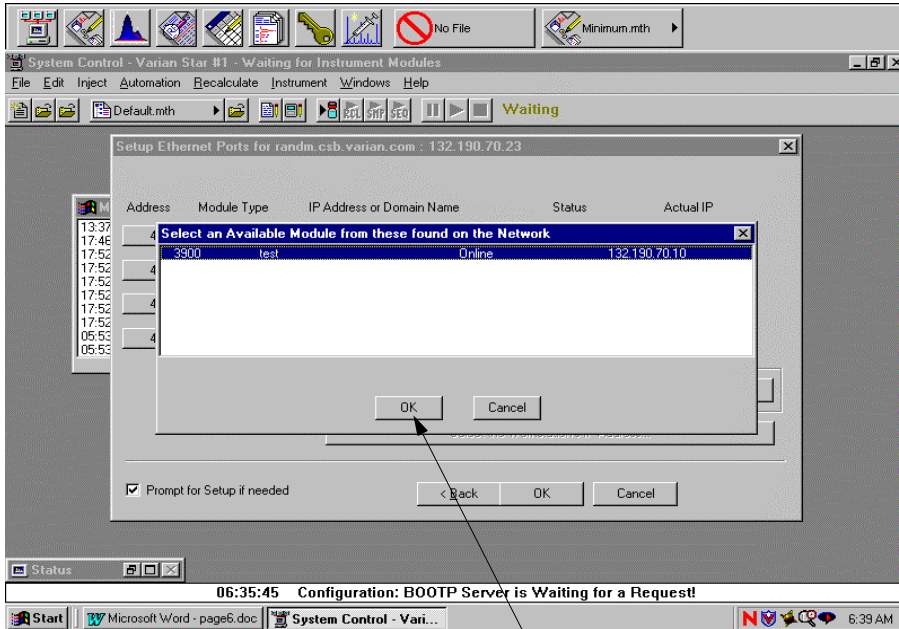
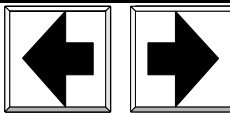

CLICK HERE
STEP 1.3.11

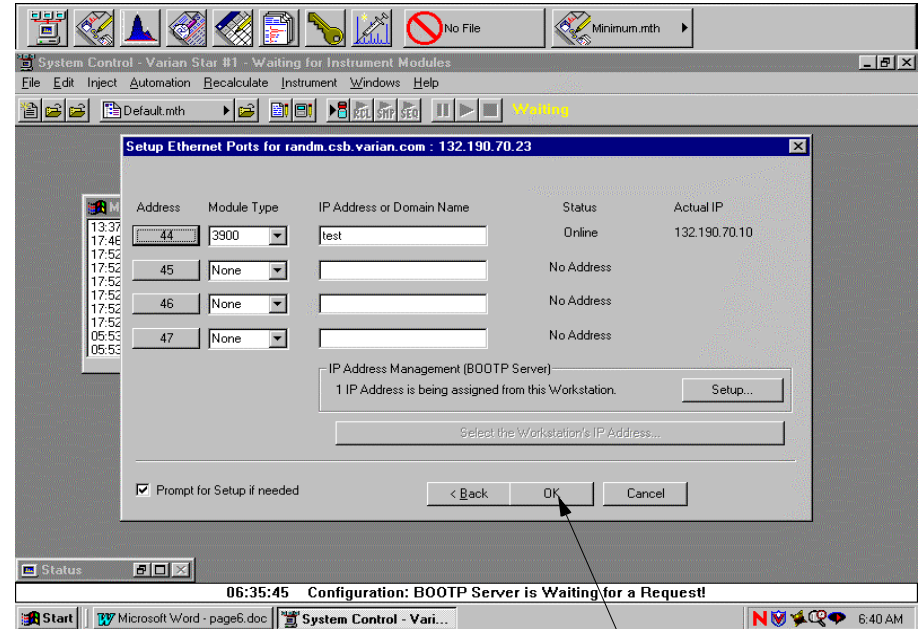

CLICK HERE
STEP 1.3.12

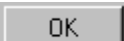
1.3.11 Wait for data to appear, then click the  button.

1.3.12 Click the  button.

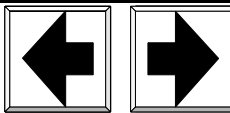

CLICK HERE
STEP 1.3.13

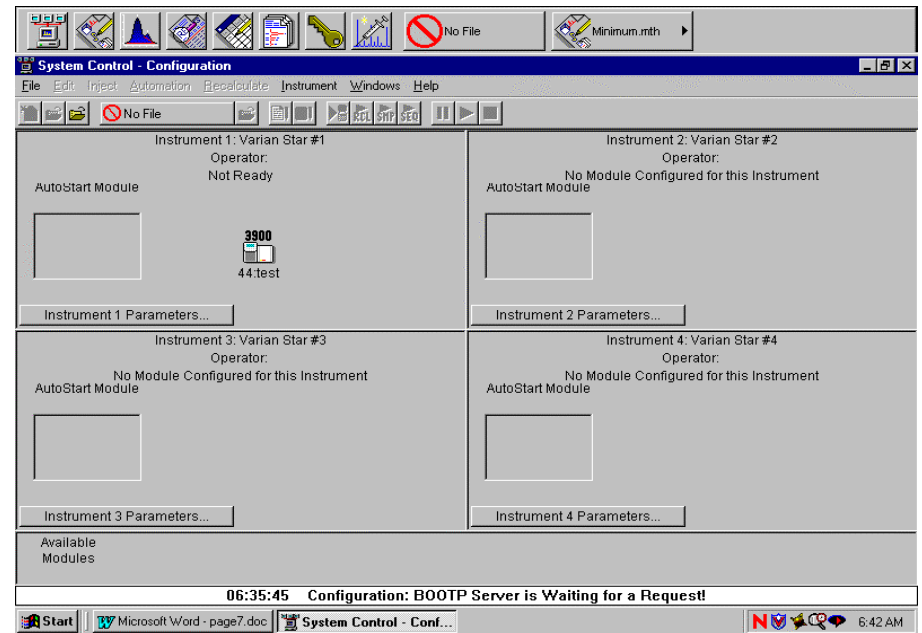
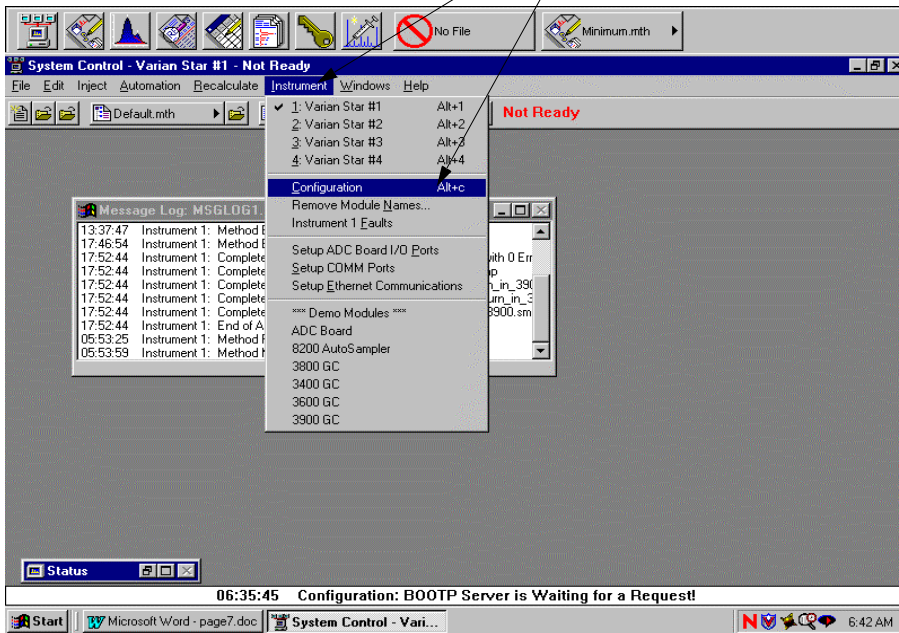

1.3.13 Click on the Instrument menu **Instrument**. Then click the **configuration** item as shown.

1.3.14 Verify that the 3900 icon is in the Instrument 1 box. If the 3900 icon is at the bottom of the screen, click and drag it to the location shown. Double click on the icon.

Note: If the icon doesn't appear, or become active, turn 3900 off and then on again.

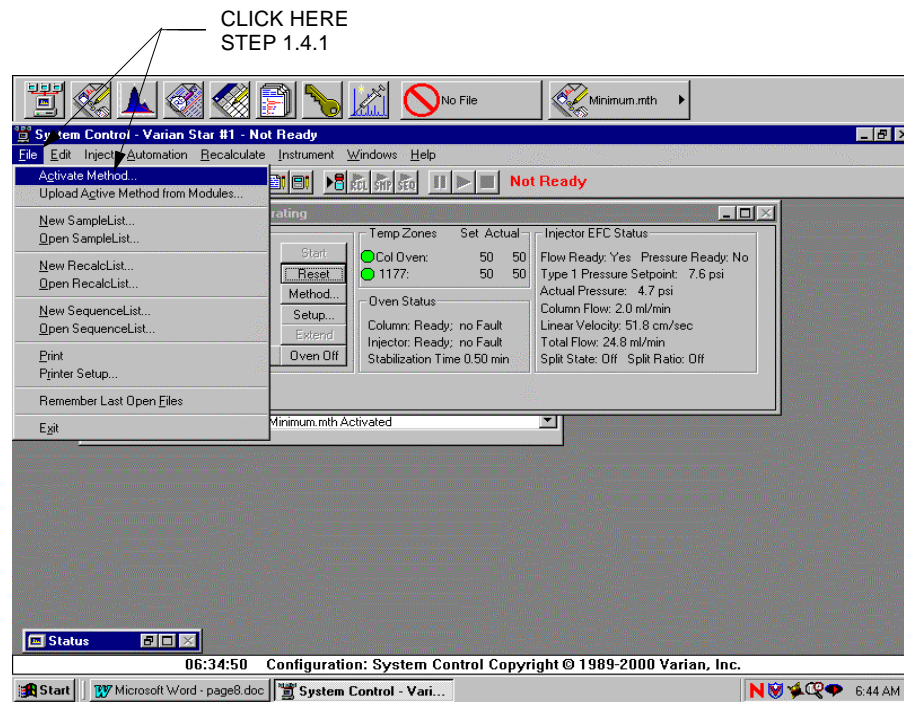
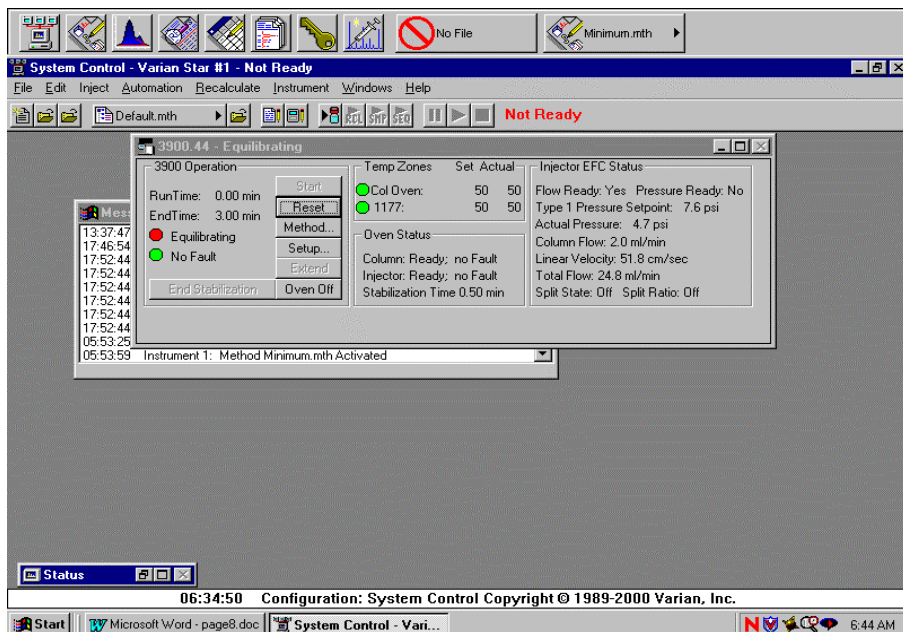
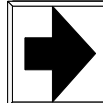
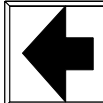

1.3.15 The screen should look similar to this when the 3900 is online.

1.4 LEAK TEST

1.4.1 Open Leak_Test_3900.mth by clicking **File** and then clicking **Activate Method...**

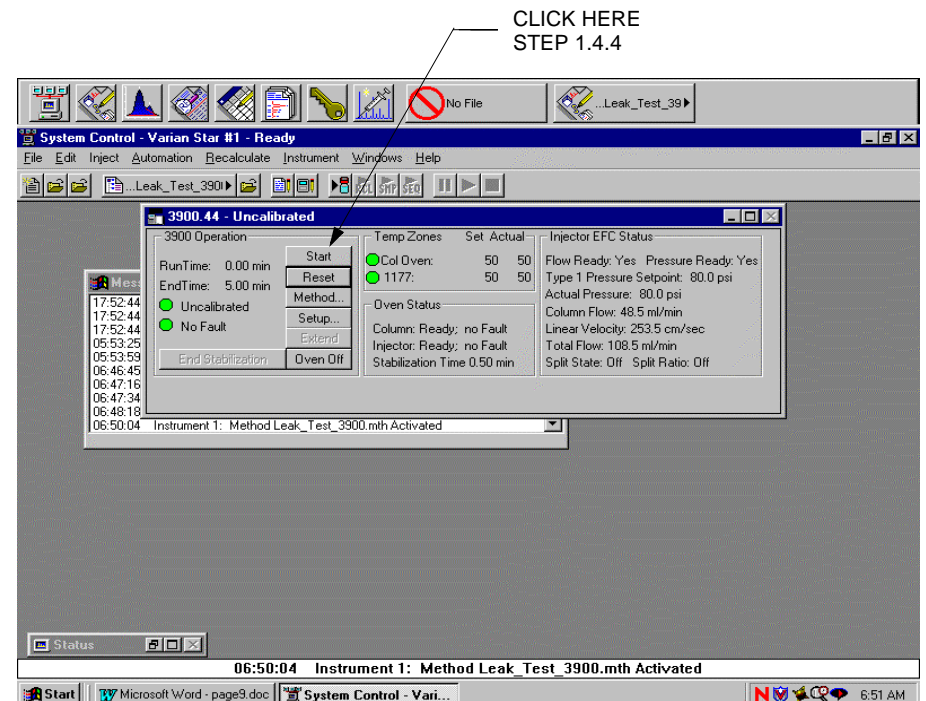
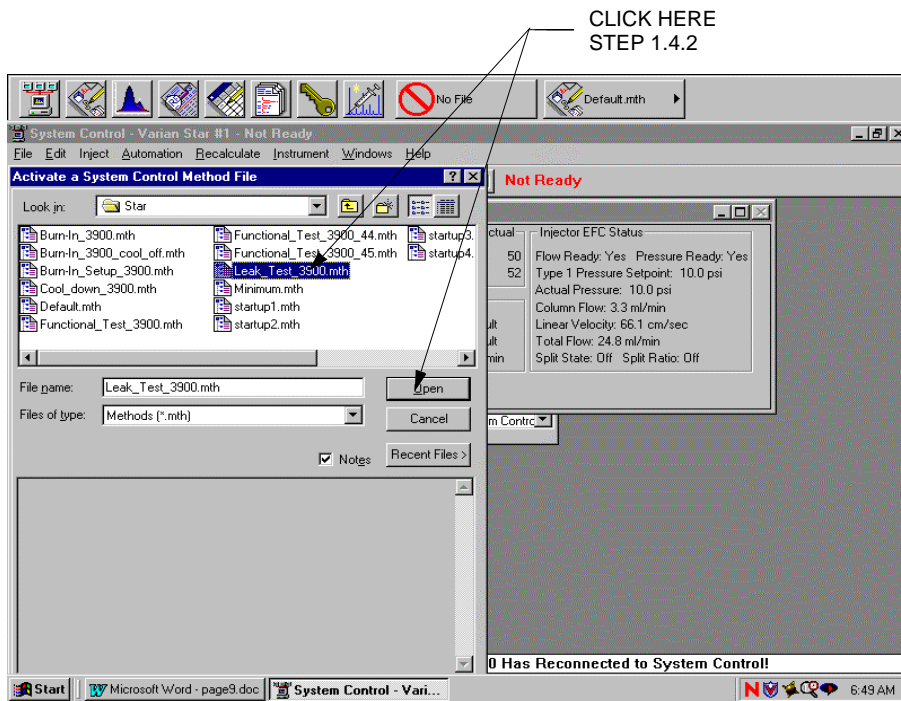

- 1.4.2 In the list, click on Leak_Test_3900.mth and then click **open**.
- 1.4.3 In the Injector EFC Status block, the Type 1 Pressure Setpoint and the Actual Pressure should go to 80.0 psi. Note: Assure Col Oven and 1177 Actual temperatures stabilize at the Set values.
- 1.4.4 After the Stabilization Time has reached zero, and the Start button has become active, then click the **Start button**, turn off the helium and record the Actual Pressure value. This will be your beginning value.
- 1.4.5 After the Runtime reaches 5.00 min, record the Actual Pressure value. This will be your ending value.
- 1.4.6 The difference between the beginning and ending values should be less than 0.4 psi.
- 1.4.7 Turn helium back on.

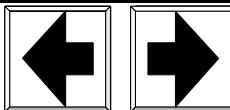

CLICK HERE
STEP 1.5.1

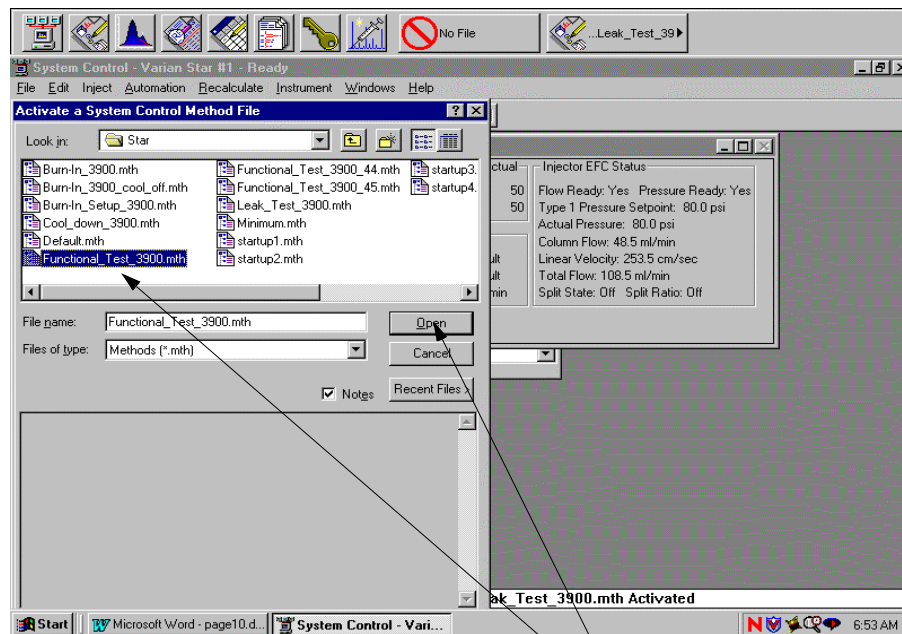
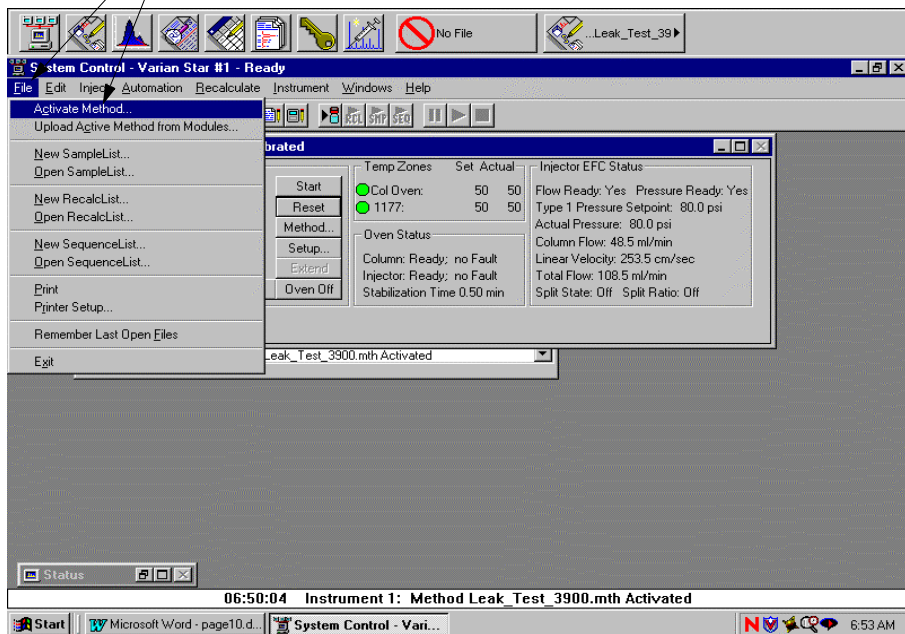

CLICK HERE
STEP 1.5.2

1.5 FUNCTIONAL TEST

1.5.1 Open Leak_Functional_3900.mth by clicking **File** and then clicking **Activate Method...**

1.5.2 In the list, click on Functional_Test_3900.mth and then click **open**.

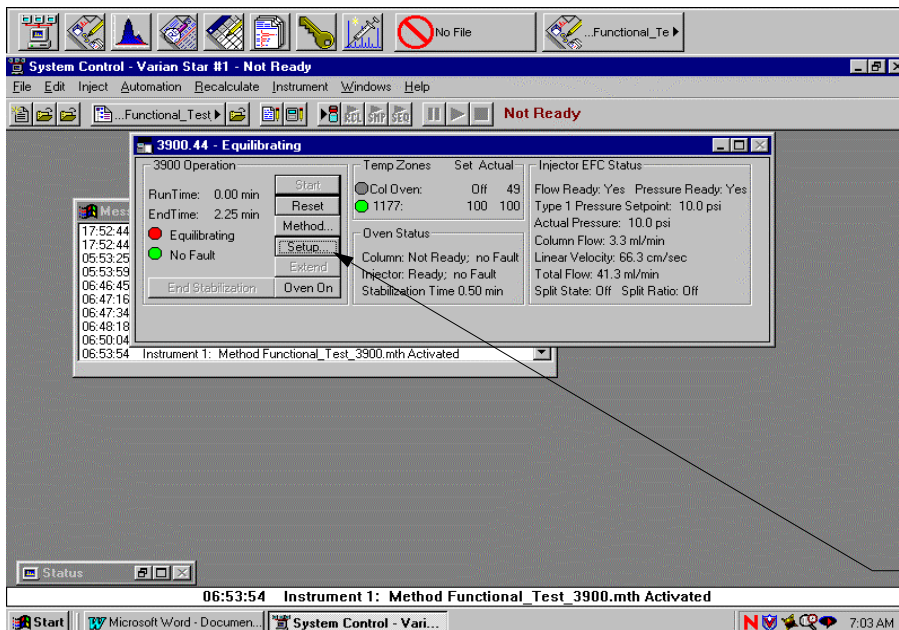
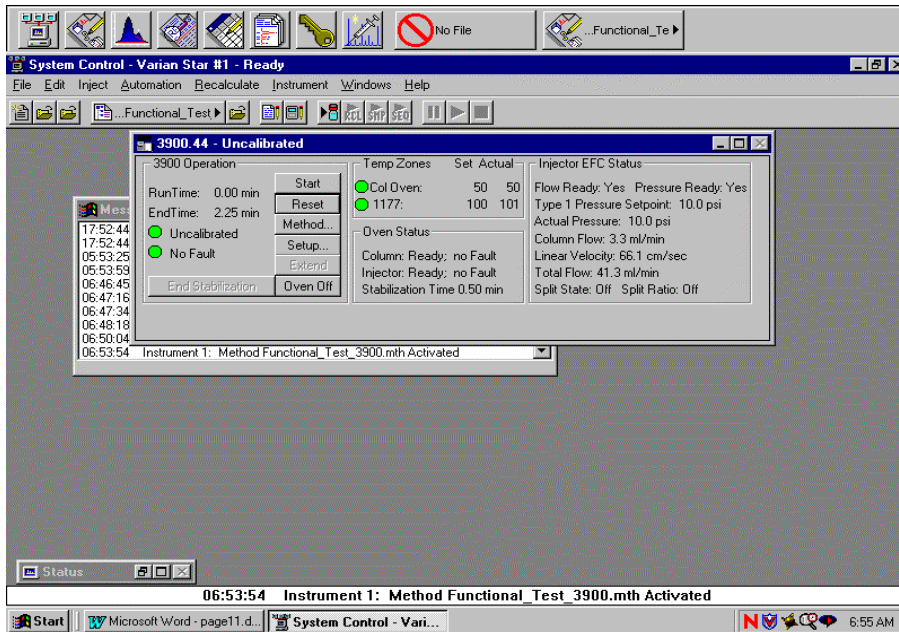
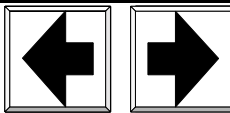

1.5.3 Verify initial values:

- A) Pressure Set point and Actual Pressure equilibrate to 10psi.
- B) Oven temp. equilibrates to 50 deg.
- C) Injector temp. equilibrates to 100 deg.
- D) Split state and ratio are off.
- E) No faults exist.

1.5.4 At the end of stabilization, tap the 3900 injector switch to begin the run.

1.5.5 During the run verify the following:

- A) During first minute.
 - I. Oven vent closes completely during oven heat-up.
 - II. Oven heats up to and stabilizes at 100 deg.
 - III. Split state on, split ratio 10, Total Flow increases.
 - IV. Pressure rises towards 22.5.
- B) During second minute.
 - I. Pressure stabilizes at 22.5.
 - II. Oven vent opens completely during oven cool down.
 - III. Oven cools to and stabilizes at 50 deg.
 - IV. Split ratio changes to 100, Total Flow increases.

- C) After 2 minutes into run split ratio changes to 20, Total Flow decreases.
 - I. At end of run. Split state and ratio are off, Total Flow decreases.

1.5.6 Open oven door and verify oven turns off.

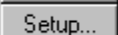
1.5.7 Verify 3900 faults, by clicking on  .

CLICK HERE
STEP 1.4.7

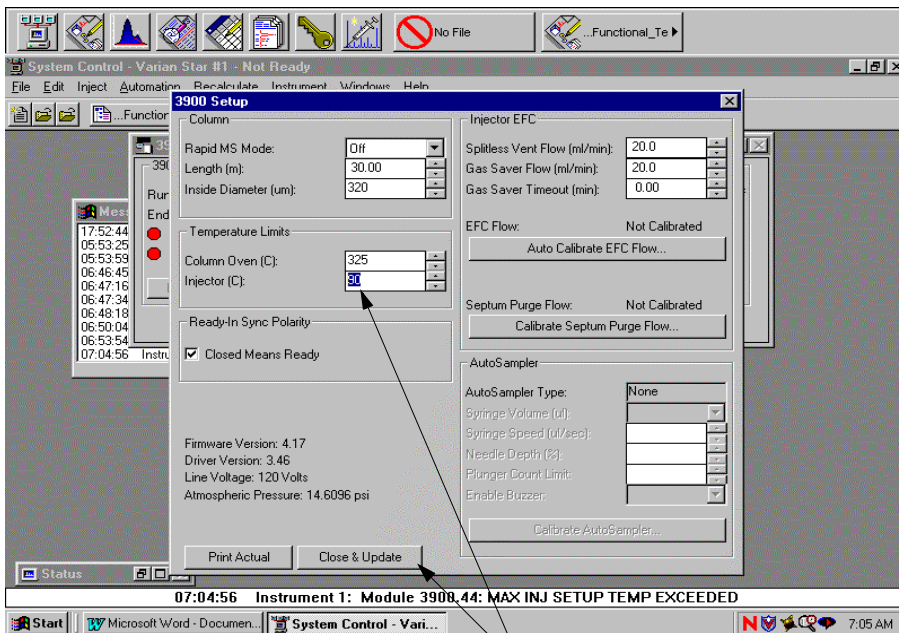
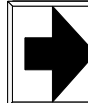

CLICK HERE
STEP 1.5.8

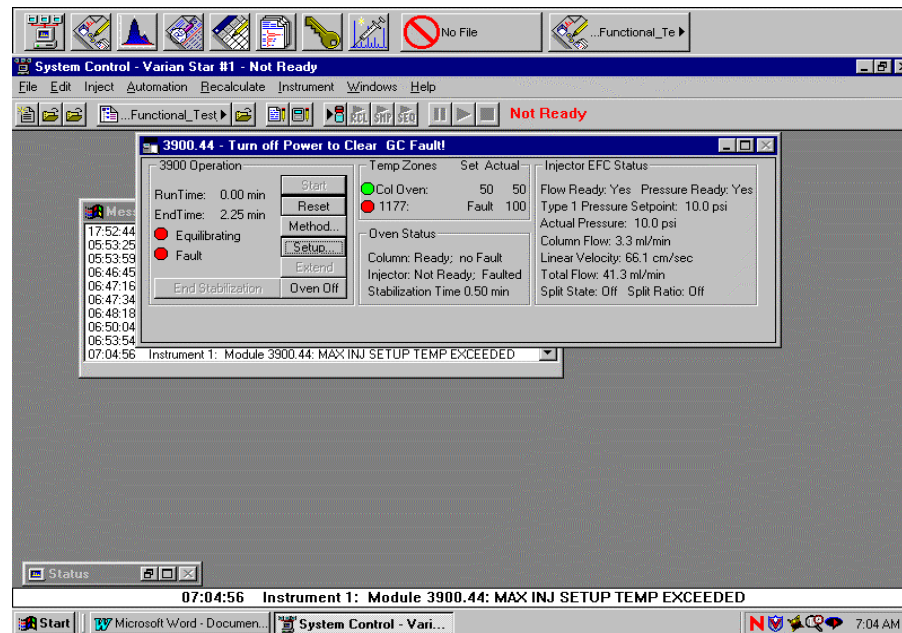

CLICK HERE
STEP 1.5.10

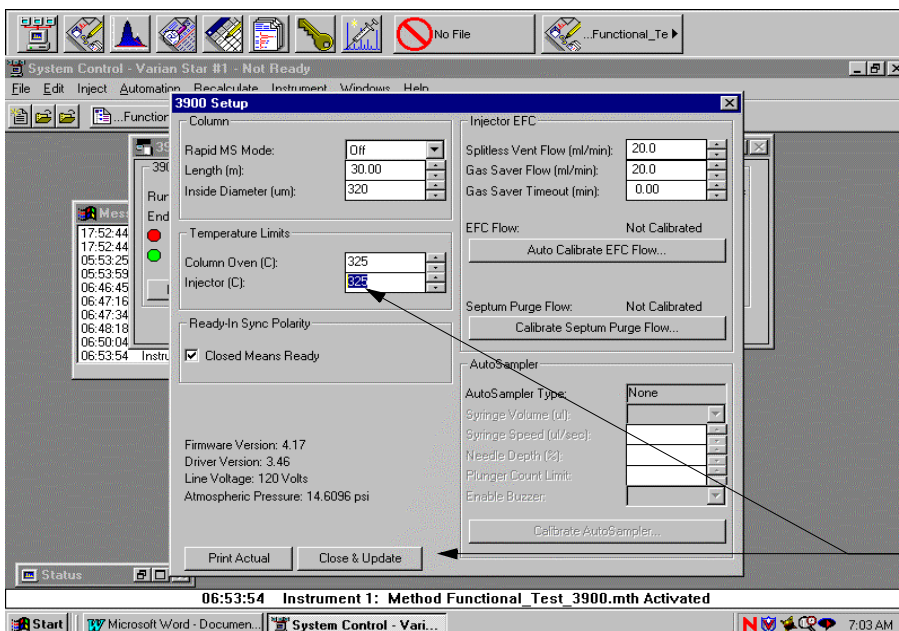

- 1.5.8 Set Injector (C) to 90 and click Close & Update.
- 1.5.9 Verify 3900 faults, and red LED illuminates on 3900.
- 1.5.10 Click **Setup...** and return the Injector (C) to 325 deg and then click Close & Update.
- 1.5.11 Exit System Control program, by clicking the **File** menu and then clicking **Exit**.
- 1.5.12 Turn off 3900 and helium. Disconnect power, computer cable and helium line.
- 1.5.13 Remove injector column fitting cap and uncap and reconnect septum purge line.

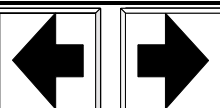

1. 3900GC GALILEO CONNECTION, ESTABLISH COMMUNICATIONS, FLOW CHECK AND BURN-IN

Warning: Before and during, heating of the injector, make sure Helium is flowing through it.

Note: While using the computer, the term "click" refers to using the mouse to position the pointer to the required location and pushing the left mouse button.

Note: If the instrument fails to meet the required specifications, troubleshoot accordingly or contact a manufacturing engineer for assistance.

1.1 3900GC CONNECTION

1.1.1 With the power switch in the off position, connect the instrument to the correct voltage and attach computer cable. Connect and turn on helium to the instrument. Install test column, w/adaptor and seal, to injector (Column is ~18" x 1/8" packed column).

1.2 ESTABLISH COMMUNICATIONS

1.2.1 Turn on the computer. After booting up, the Star Toolbar should be visible on the screen.

1.2.2 Click on the System Control/Automation



button.

CLICK HERE
STEP 1.2.2

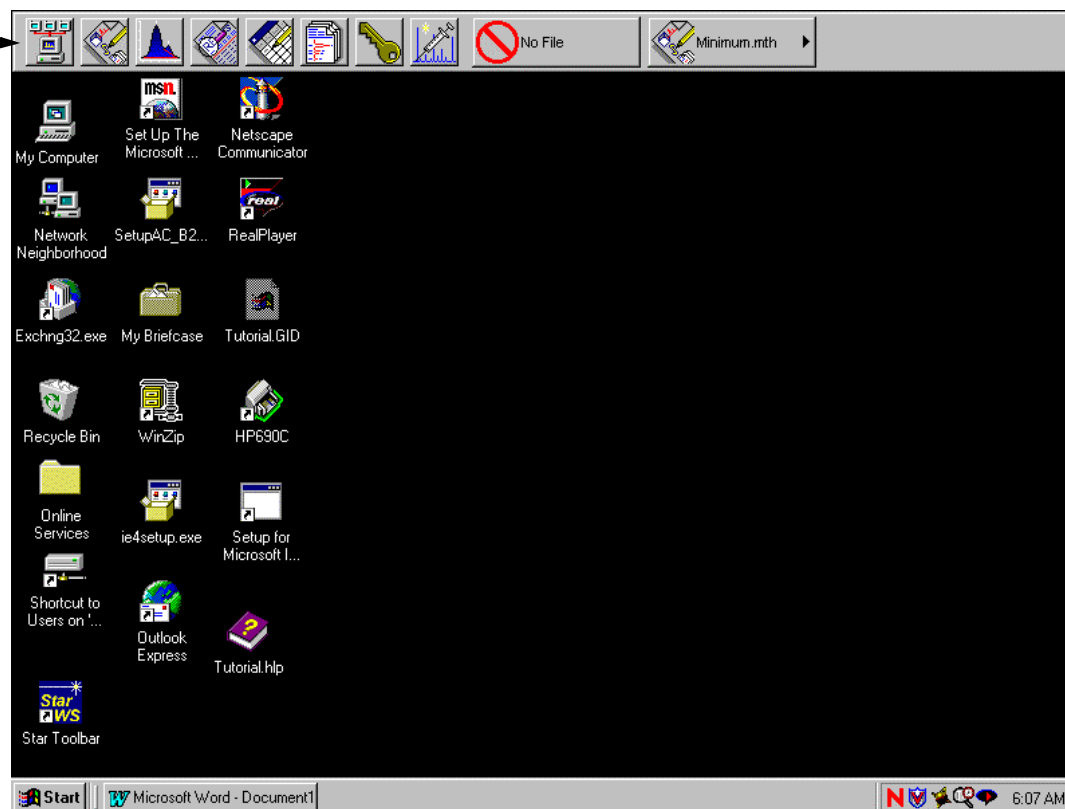

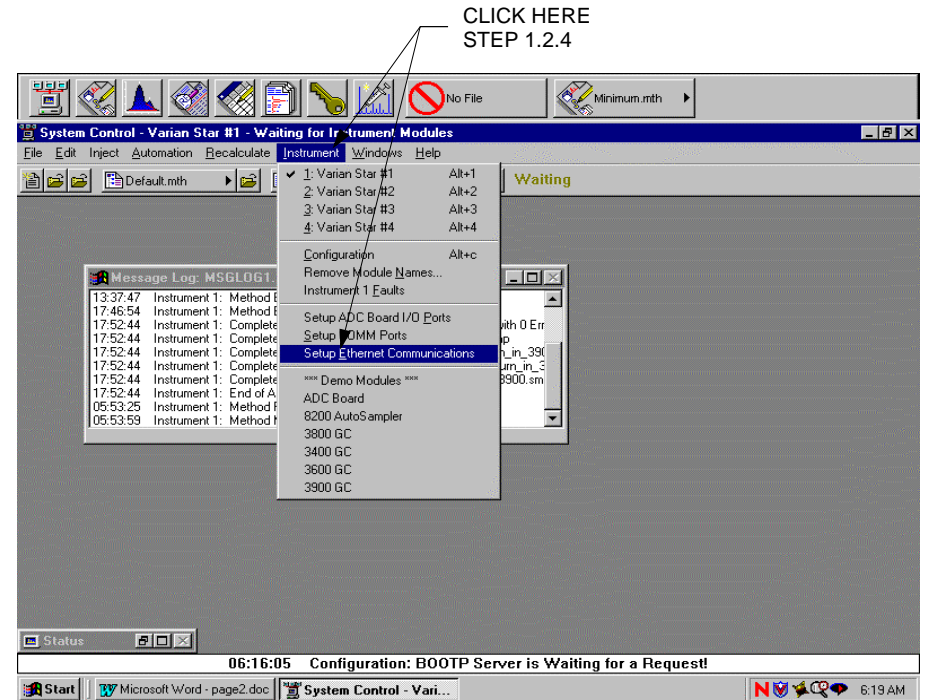
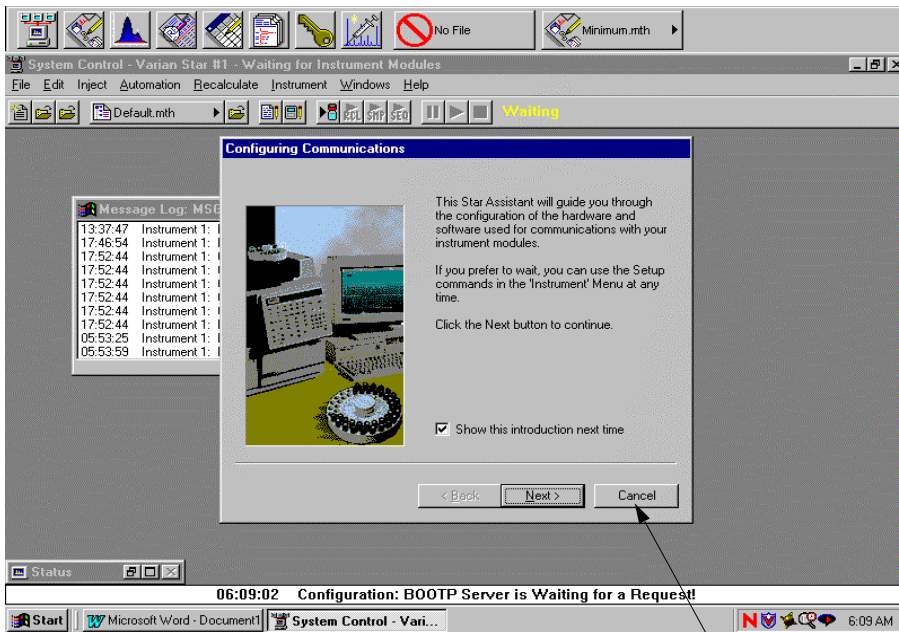
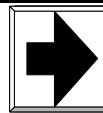
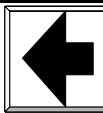

1.2.3 Click on the **Cancel** button.

1.2.4 To establish communications between the computer and the 3900GC, click on the **Instrument** menu. Then click the **Setup Ethernet Communications** item.

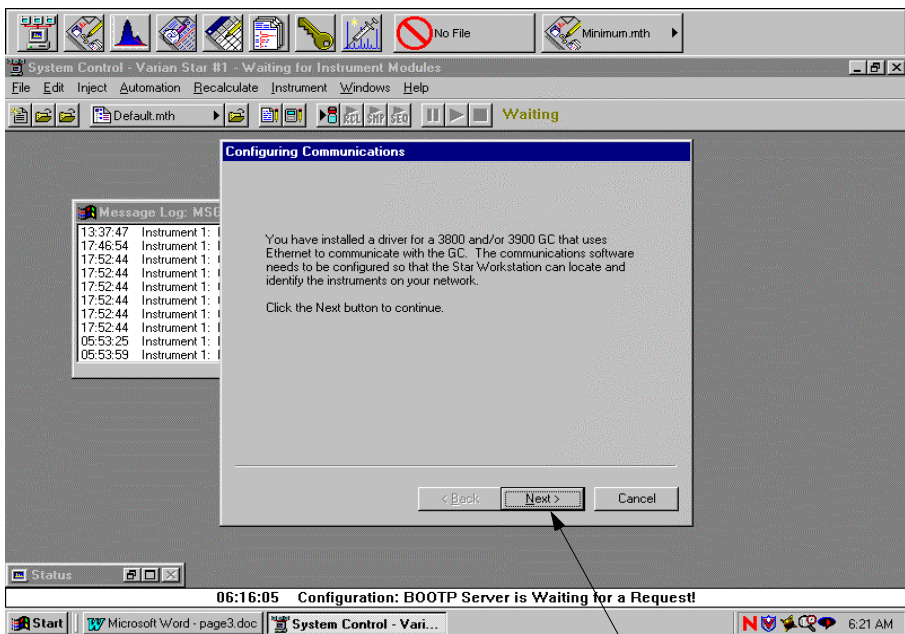

CLICK HERE
STEP 1.2.5

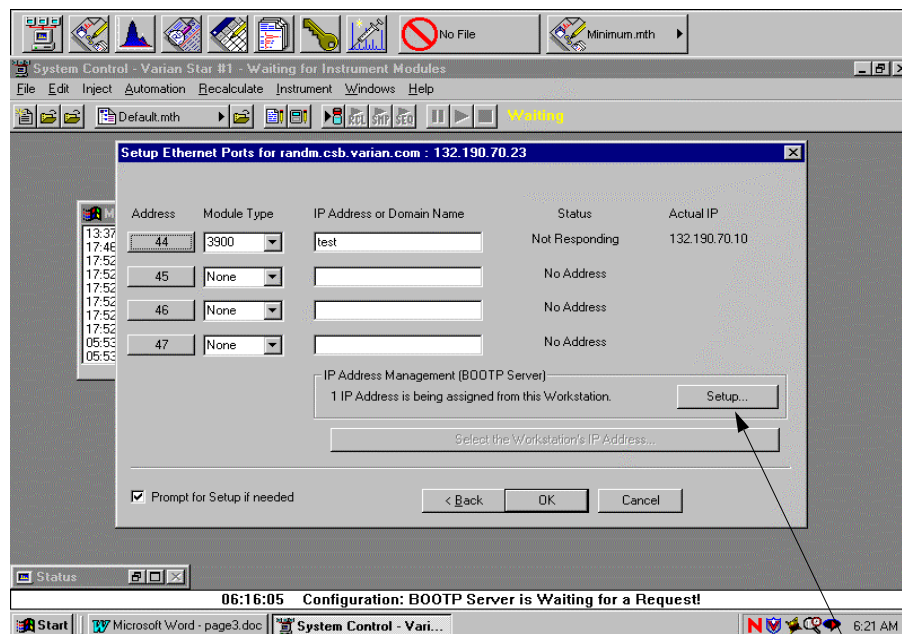

CLICK HERE
STEP 1.2.6

1.2.5 Click the  button.

1.2.6 Click the  button.

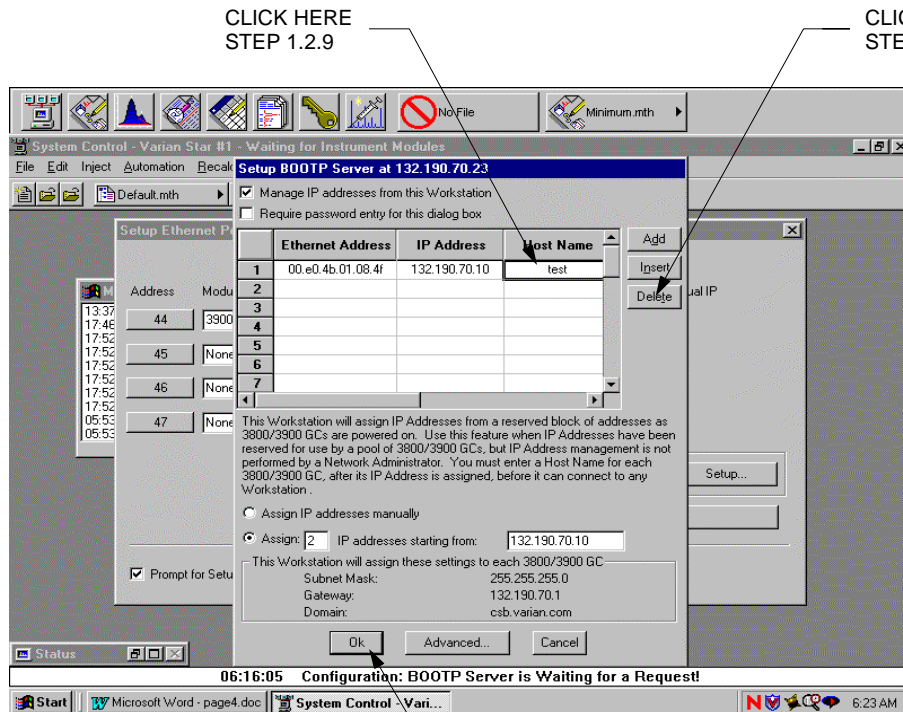

CLICK HERE
STEP 1.2.9

CLICK HERE
STEP 1.2.7

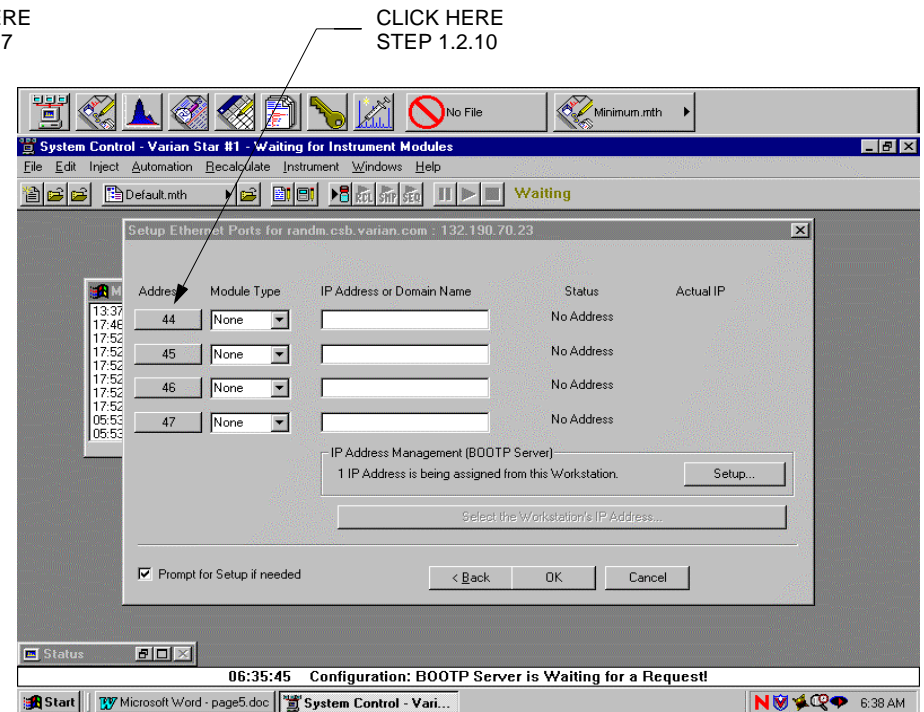

CLICK HERE
STEP 1.2.10

CLICK HERE
STEP 1.2.9

- 1.2.7 Turn the 3900 power switch on.
- 1.2.8 If the last 4 digits of the serial number, of the 3900 being tested, are already in the Host Name block, skip the next step.
- 1.2.9 After new data appears on a line in the table, click the box under **Host Name** and replace <unnamed> with the last 4 digits of the 3900 serial number and push enter on the keyboard. Delete lines of data in the table that correspond to instruments no longer connected to the burn-in computer. This is done by clicking a box with data in it, and then clicking delete. Next, click **Ok**.
- 1.2.10 Click the button, of an Address not being used.

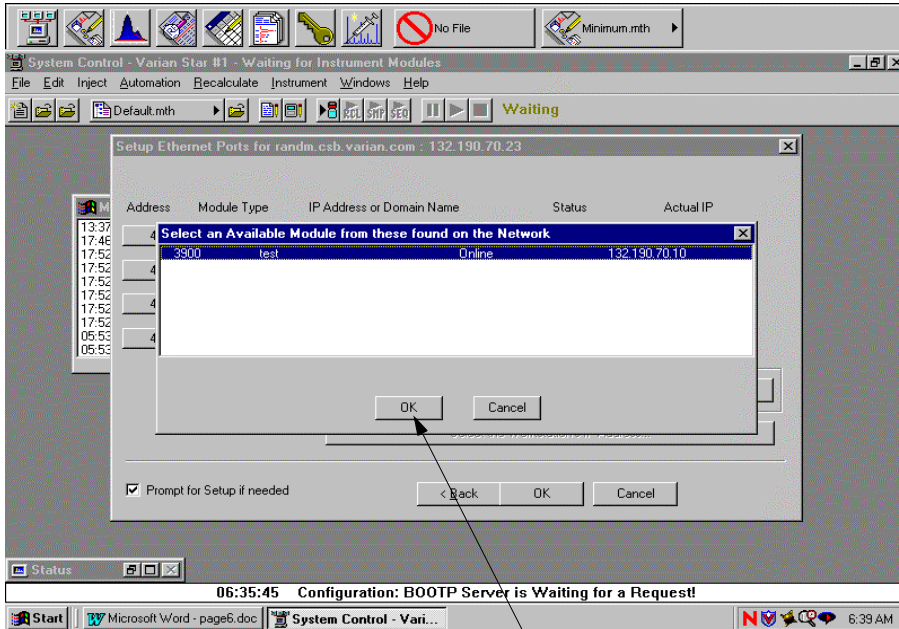
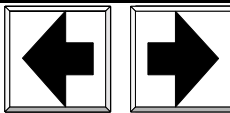

CLICK HERE
STEP 1.2.11

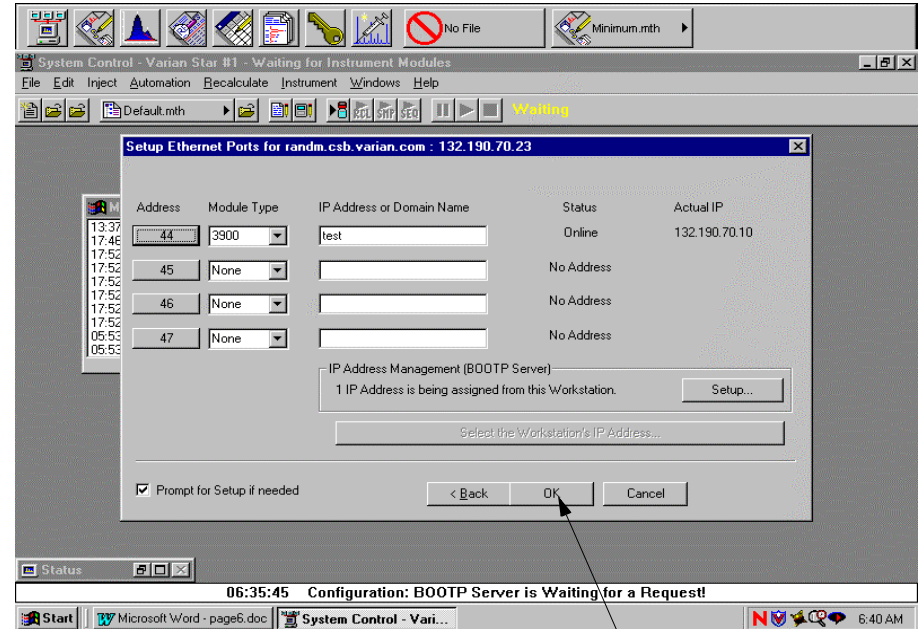

CLICK HERE
STEP 1.2.12

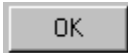
1.2.11 Wait for new data to appear, click on the line corresponding to the 3900 being setup, then click the  button.

1.12 Click the  button.

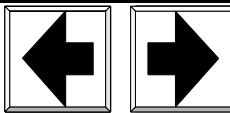

CLICK HERE
STEP 1.2.13

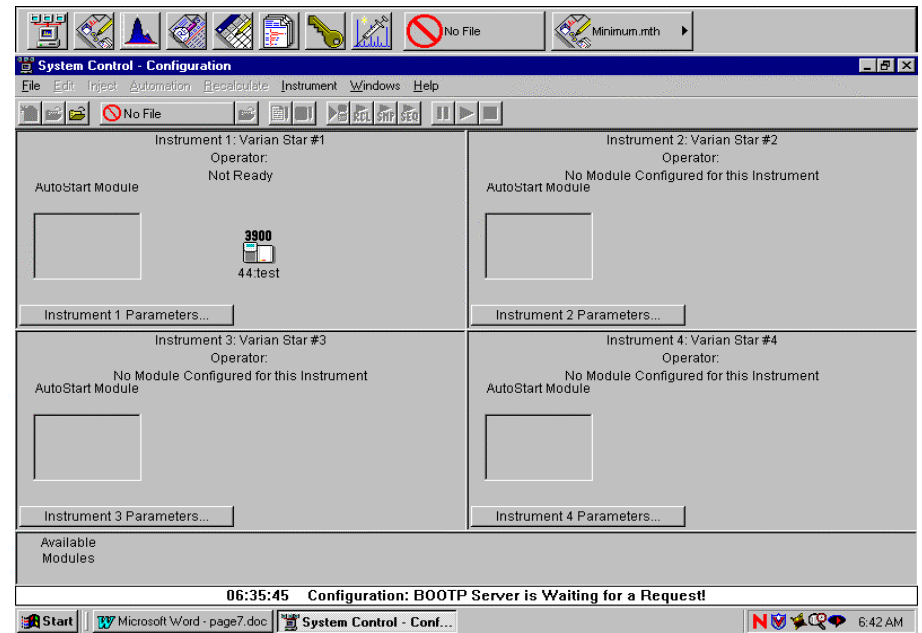
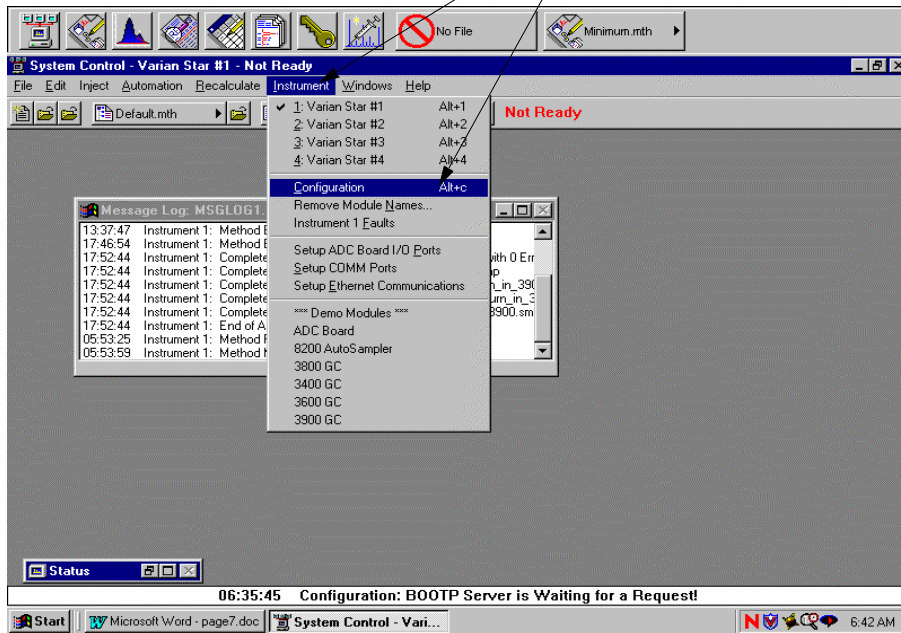

1.2.13 Click on the Instrument menu **Instrument**. Then click the **configuration** item as shown.

1.2.14 Verify that the 3900 icon, with the Address selected in step 1.2.10, is in an Instrument box. If the 3900 icon is at the bottom of the screen, click and drag it to an unused Instrument box. Double click on the icon.

Note: If the icon doesn't appear, or become active, turn 3900 off and then on again.

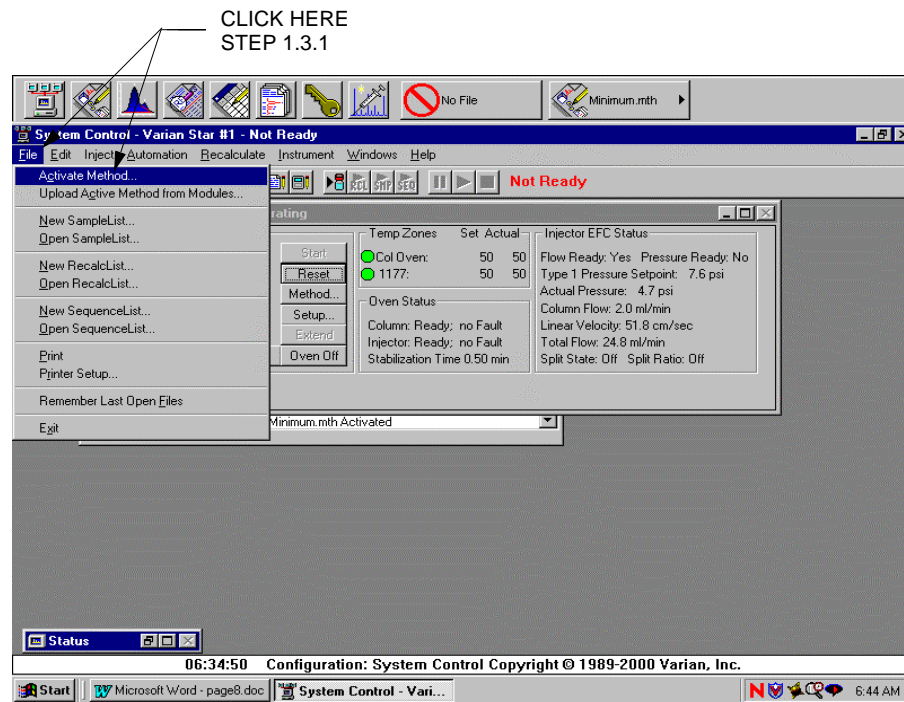
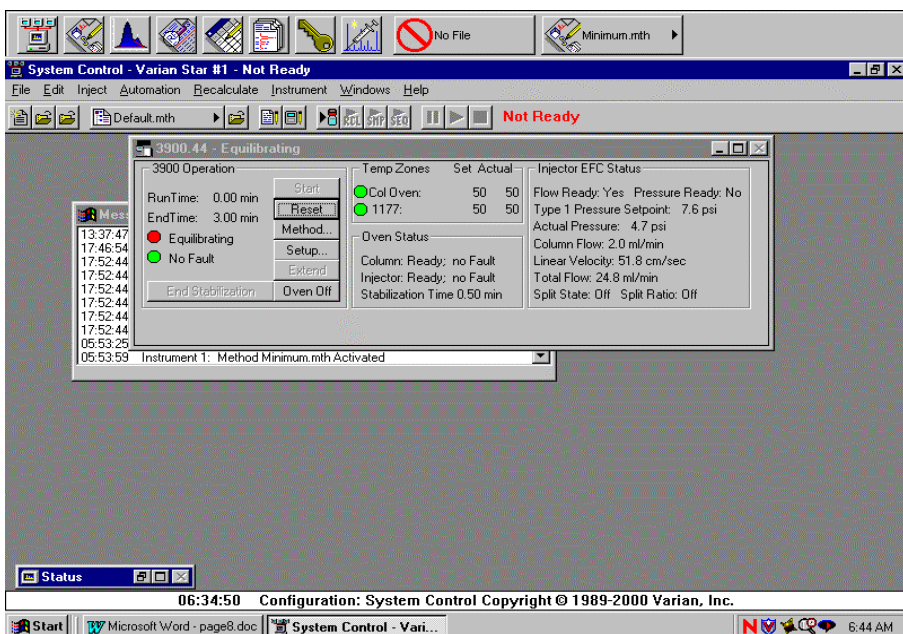

1.2.15 The screen should look similar to this when the 3900 is online.

1.3 FLOW CHECK

1.3.1 Open Burn-in_Setup_3900.mth by clicking **File** and then clicking **Activate Method...**



CLICK HERE
STEP 1.3.2

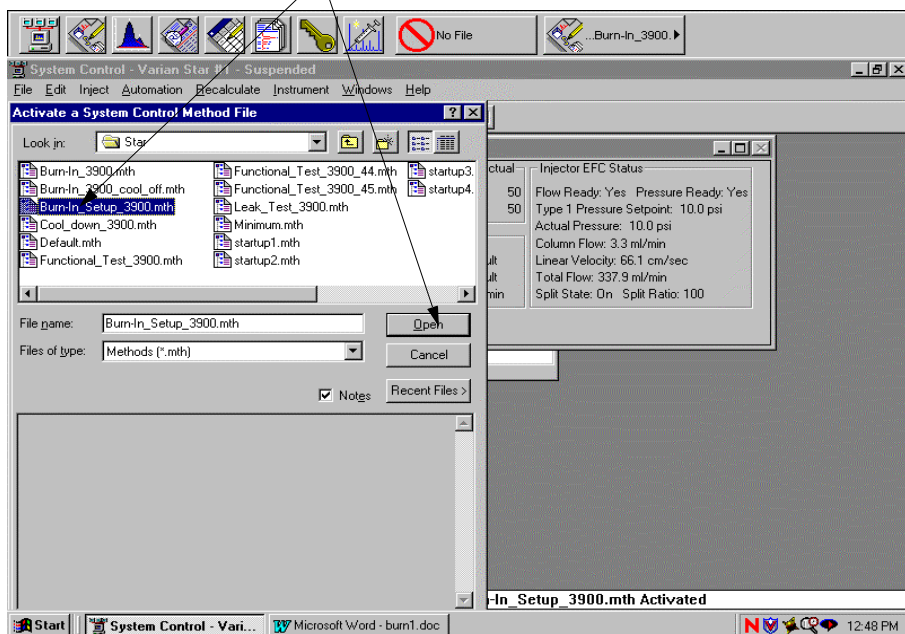

1.3.2 In the list, click on **Burn-in_Setup_3900.mth** and then click **Open**.

1.3.3 Critical data:

- A) Go to **Setup...** to check the following:
 - I. Column length = 30; Column bore = 320
 - II. Gas Saver Time Out set to zero for burn-in purposes
- B) The following can be checked on the status screen:
 - I. Injector and Oven Temp. = 50 C
 - II. Split State to on; Ratio to 100
 - III. Pressure set to 10 psi
- C) Adjust sport valve flow to 5-10 mL/min.
- D) Verify flow coming from test column is 30-100 mL/min.
- E) Verify that there is flow out of EFC vent tube.

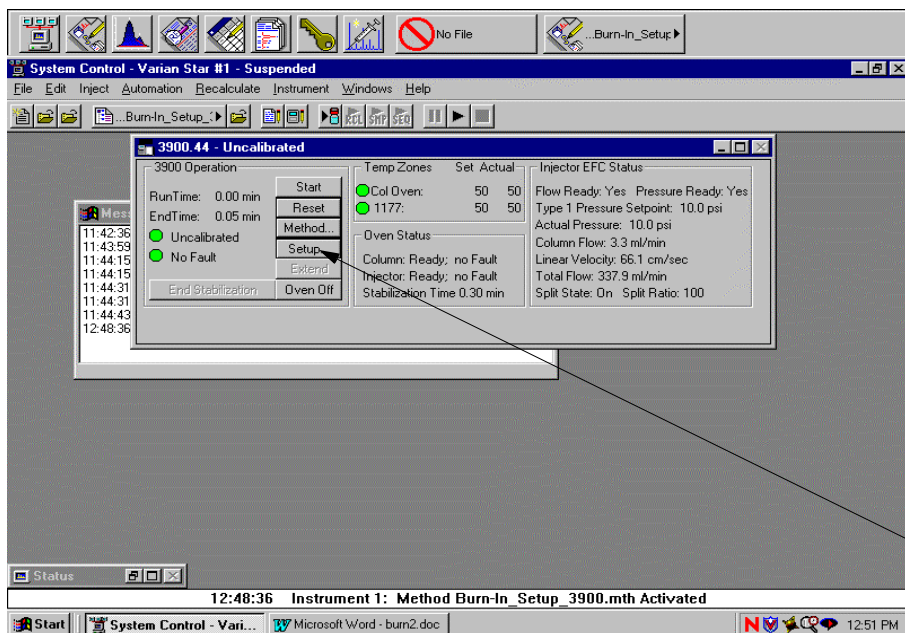

CLICK HERE
STEP 1.3.3

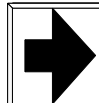
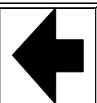

CLICK HERE
STEP 1.4.2

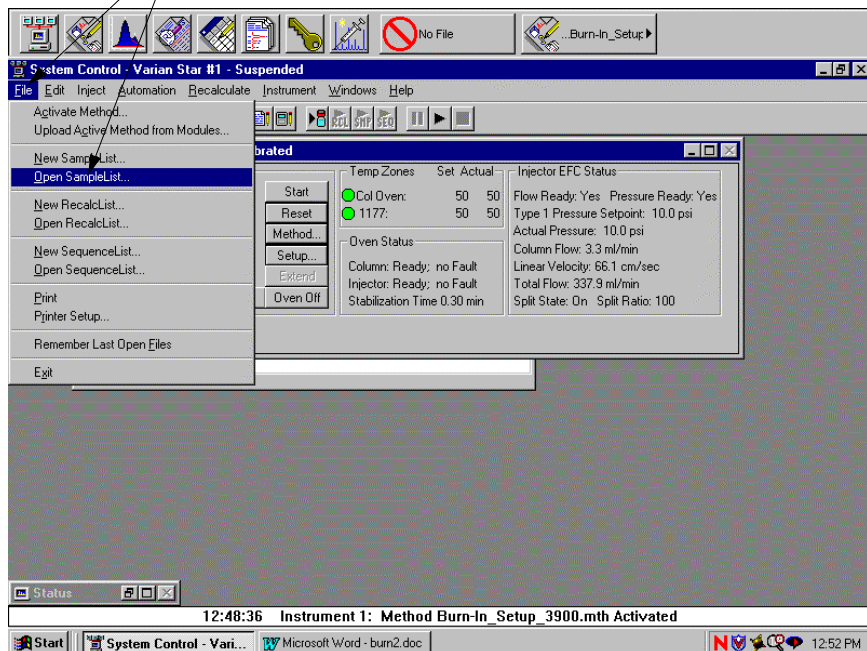

CLICK HERE
STEP 1.4.3

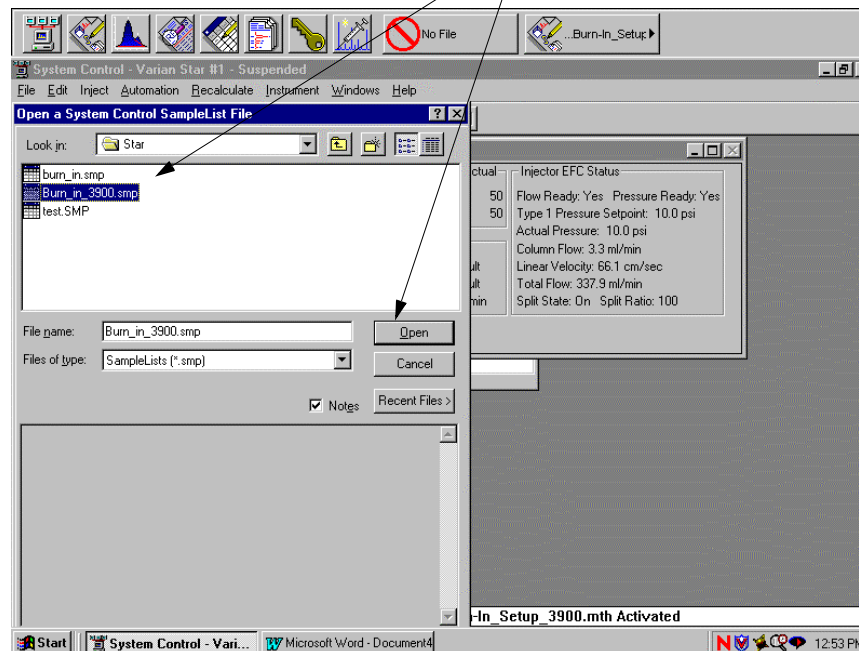

1.4 BURN-IN

Note: The 3900 Connection and Establish Communications sections must be completed prior to performing Burn-In.

1.4.1 Remove injector nut and septum & install bake out nut with seal T-6013.

1.4.2 Open Burn-in_3900.smp by clicking **File** and then clicking **Open SampleList...**

1.4.3 In the list, click on **Burn-in_3900.smp** and then click **Open**.

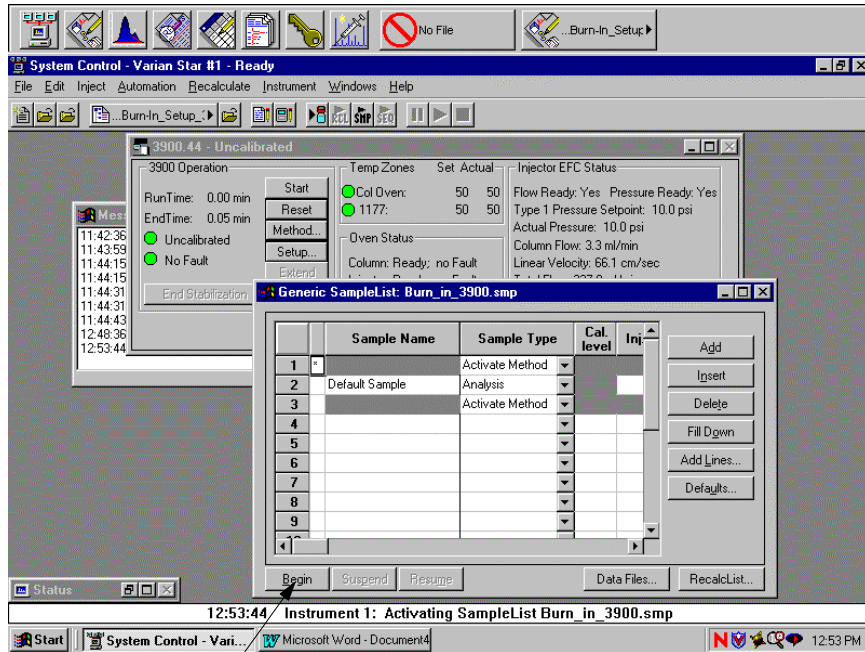

CLICK HERE
STEP 1.4.4

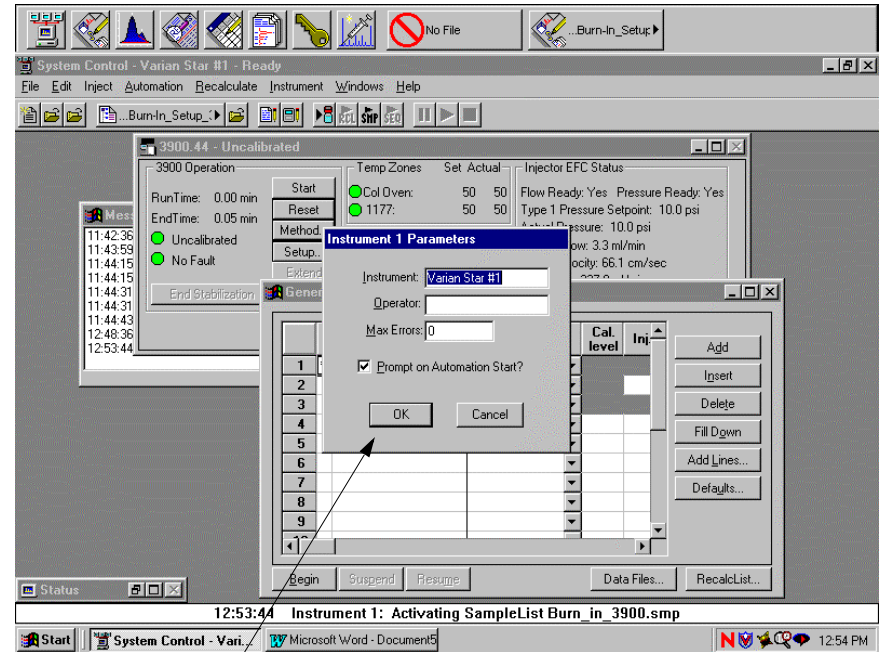

CLICK HERE
STEP 1.4.5

1.4.4 Click Begin.

1.4.5 Click OK

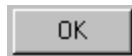

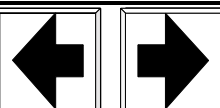

The screenshot shows the 'System Control - Varian Star #1 - Ready' application. A 'Begin Sample List' dialog box is open, prompting the user to select a method file. The text field contains 'C:\StarBurn-In_Setup_3900.mth'. Below the dialog, the '3900.44 - Uncalibrated' window is visible, showing a table with columns for 'Begin', 'Suspend', and 'Resume'. The status bar at the bottom indicates '12:53:44 Instrument 1: Activating SampleList Burn_in_3900.smp'.

CLICK HERE
STEP 1.4.6

1.4.6 Click OK

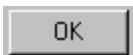



System Control - Varian Star #1 - Waiting for All Modules Ready

File Edit Inject Automation Recalculate Instrument Windows Help

Burn-In_3900.mth Waiting

3900.44 - Equilibrating

3900 Operation

RunTime: 0.00 min
EndTime: 240.00 min

Start
Reset
Method...
Setup...
Extend
End Stabilization

Temp Zones Set Actual

Col Oven: 350 52
1177: 320 50

Oven Status

Column: Not Ready: no Fault

Injector EFC Status

Flow Ready: No Pressure Ready: Yes
Type 1 Pressure Setpoint: 10.0 psi
Actual Pressure: 10.0 psi
Column Flow: 3.3 ml/min
Linear Velocity: 66.0 cm/sec

Generic SampleList: Burn_in_3900.smp

| | Sample Name | Sample Type | Cal. level | Inj |
|---|----------------|-----------------|------------|-----|
| 1 | * | Activate Method | | |
| 2 | Default Sample | Analysis | | |
| 3 | | Activate Method | | |
| 4 | | | | |
| 5 | | | | |
| 6 | | | | |
| 7 | | | | |
| 8 | | | | |
| 9 | | | | |

Begin Suspend Resume Data Files... RecalList...

12:56:39 Instrument 1: Method Burn-In_3900.mth Activated

System Control - Vari... Microsoft Word - Document6 12:56 PM

1.4.7 After heated zones reach set temperatures and Stabilization has ended, click **Start**.

Critical data:

- A) Column Oven temp. = 350 C
- B) Injector temp. = 320 C; 260 C after 4 hrs

1.4.8 Burn-in is performed for a minimum of 4 hours, and terminated at the test technicians discretion.

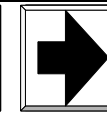
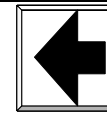
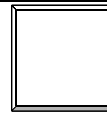
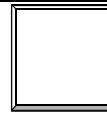

1. DIMMPC PROGRAMMING PROCEDURES COMPUTER, 386 DIMMPC 78-911010-00 TO 03-910873-01

NOTE: The person performing this procedure must be properly grounded with an anti-static wrist strap.

1.1 PROGRAMMING PROCEDURES

- 1.1.1 Remove the DIMMPC (Dual In-line Memory Module Personnel Computer 386), 78-911010-00 from its electrostatic shielding box and install into the uppermost connector (Labeled "DIMMPC") on the JUMPtec evaluation board, (1JDMAD2).
- 1.1.2 With the latest revision 3900 DIMMPC Initialization Diskette, 03-910873-03 installed in the Floppy drive, depress the POWER ON button of the DIMMPC programming fixture T# 9114.
- 1.1.3 The computer will begin to boot-up and the monitor should display, "READY TO PROGRAM THE CMOS SETUP PRESS ANY KEY TO CONTINUE...." Depress the "SPACE" key on the keyboard.
- 1.1.4 In a few seconds the monitor will display, "ALL FILES IN DIRECTORY WILL BE DELETED! ARE YOU SURE (Y/N)?" Depress the "Y" and then the "ENTER" keys on the keyboard.
- 1.1.5 After approximately one minute, the monitor should display "THE CMOS SETUP IS CONFIGURED AND PROGRAMS COPIED TO DIMMPC A:\JUMPTec>".
- 1.1.6 Depress the "CTRL/ALT/DEL" keys on the keyboard or depress the button labeled "RESET" on the evaluation board and verify the system initializes and the "TIMEOUT TASK ticks =" begin to count up.
- 1.1.7 Turn OFF the DIMMPC programming fixture.
- 1.1.8 Affix a printed label (AVERY P/N 05412 or equivalent) that reads: "03-910873-01 ©2000 VARIAN" on the DIMMPC. Locate label on the second largest IC of DIMMPC.
- 1.1.9 Remove the DIMMPC from the programming fixture and re-package it into its electrostatic shielding box.
- 1.1.10 Back flush 78-911010-00 part and place programmed part in 03-910873-01 location.

1.2 RE-PROGRAMMING PROCEDURES

- 1.2.1 Perform steps 1 and 2 of programming procedure only depress and hold the "DELETE" key while the computer begins to boot-up.

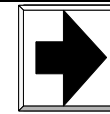
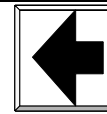
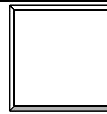
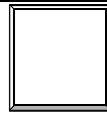

- 1.2.2 Under 'STANDARD SETUP" depress the "ENTER" key. Using the "right arrow" key, move over to the "FLOPPY A" Icon and depress the "ENTER" key again.
- 1.2.3 A box entitled "FLOPPY A" should appear on the monitor with the "NOT INSTALLED" box highlighted. Depress the "down arrow" key four times until the "1.44 MB 3 1/2" " box is highlighted and depress "ENTER".
- 1.2.4 Depress the "ESC" key twice, (to the save and exit box) and then depress the "ENTER" key.
- 1.2.5 Continue steps 1.1.3 through 1.1.9 (omitting step 1.1.8) of the programming procedure.

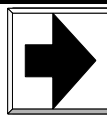
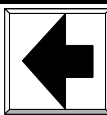

| | | |
|--|---|--|
| 03-925210-01 HOUSING, POWER SWITCH, STANDARDpg. 4 | 03-933014-01 ASSY, COLUMN OVEN HEATER, 120V pg. 14 | 03-933207-01 SPACER, SOFT CHASSIS FOOTpg. 2 |
| 03-925306-01 3800 VENT MOTOR.....pg. 8 | 03-933151-01 ASSY, COLUMN RACK..... pg. 23 | 03-933500-01 3900, TRANSFORMER, 120VACpg. 8 |
| 03-925315-02, 3 PLCS PLASTIC, FOOT.....pg. 2 | 03-933158-01 DOOR CATCH..... pg. 6 | 03-933503-01 ASSY, CABLE, AC INPUTpg. 8 |
| 03-925375-03 ASSY, TEMP PROBE, COLUMN OVEN.....pg. 14 | 03-933162-01 BRACKET, VENT SHAFT pg. 12 | 03-933504-01 ASSY, HARNESS, CIRCUIT BREAKER 120VAC.....pg. 4 |
| 03-925467-03 SOLENOID, 3900 POWER FAIL.....pg. 20 | 03-933170-01 CHANNEL, FAN MOTOR MOUNT pg. 8 | 03-933505-01, (REF.) ASSY, HARNESS, CIRCUIT BREAKER 101/230VAC.....pg. 4 |
| 03-925467-03 SOLENOID, 3900 POWER FAIL.....pg. 21 | 03-933174-01 COVER, RIGHT SIDE OVEN pg. 6 | 03-933508-01 ASSY, CABLE, EFC, 3900.....pg. 20 |
| 03-925594-01 POWER LINE EMI/RFI FILTERpg. 8 | 03-933180-01 BRACKET, UPPER HINGE pg. 2 | 03-933509-01 ASSY, HARNESS, DOOR./LED.....pg. 4 |
| 03-925996-01 ASSY, 1177 INJECTORpg. 16 | 03-933181-01 BRACKET, LOWER HINGE pg. 2 | 03-933510-01 ASSY, CABLE, INJECTOR SWITCH.....pg. 16 |
| 03-93178-01 PANEL, LOWER FRONTpg. 4 | 03-933187-01 FAN, 8.0DIA. X 1.75 PITCH pg. 14 | 12-222008-12, 4 PLCS SCREW, 8-32 X 3/4, PAN.....pg. 2 |
| 03-933006-01 ASSY, ELECTRONICS MODULEpg. 22 | 03-933189-01 EXHAUST VENT DUCT pg. 10 | 12-901130-00, 4 PLCS SCREW, 10-32 X 3/8, SEM.....pg. 8 |
| 03-933007-01 ASSY, VENT DOOR.....pg. 10 | 03-933190-01 VENT DUCT TOP pg. 10 | 12-901161-00, 2 PLCS SCREW, 6-32 X 3/8, SEM.....pg. 20 |
| 03-933008-01 ASSY, FRONT DOOR, MODEL 3900pg. 23 | 03-933196-01 INTAKE DUCT pg. 12 | 12-901161-00, 2 PLCS SCREW, 6-32 X 3/8, SEMSpg. 8 |
| 03-933010-01 ASSY, CHASSISpg. 2 | 03-933205-02, (THIN) GASKET, TRANSFERLINE, .25 THK..... pg. 6 | 12-901161-00, 2 PLCS SCREW, SEMS, 6-32 X 3/8, SSTpg. 21 |
| 03-933012-01 ASSY, COLUMN OVEN MOTOR, 120Vpg. 12 | 03-933205-03, (THICK) GASKET, TRANSFERLINE, .37 THK..... pg. 6 | |

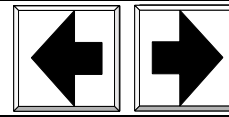

| | | |
|---|--|---|
| 12-901163-00, 2 PLCS SCREW, 8-32 X 3/8, SEM.....pg. 2 | 14-901030-00, 2 PLCS WASHER, #10 FLAT, SST pg. 20 | 24-799873-00 BUSHING, NYLON, SNAP, BLACK 5/8pg. 8 |
| 12-901163-00, 2 PLCS SCREW, 8-32 X 3/8, SEM.....pg. 4 | 14-901030-00, 2 PLCS WASHER, FLAT, #10, SST pg. 21 | 51-340093-00 CONN, AC, M, INL, 3WIRpg. 8 |
| 12-901165-00, 10 PLCS SCREW, 8-32 X 1/4, SEMSpg. 12 | 14-999410-00 WASHER, TEFLON .177ID pg. 2 | 51-406927-00 CONNECTOR HOUSING, 4 PINpg. 18 |
| 12-901165-00, 2 PLCS SCREW, 8-32 X 1/4, SEMSpg. 2 | 21-128961-00 BEARING, NYLON SLEEVE pg. 12 | 51-408249-00 CONN, HOUSING, PLUGpg. 14 |
| 12-901165-00, 2 PLCS SCREW, 8-32 X 1/4, SEM.....pg. 16 | 22-119650-00, 2 PLCS TY-WRAP, NYLON, NATURAL, SHORT (MPB) pg. 18 | 55-700713-00, (SHOWN) CIRCUIT BREAKER, 120V, 15A.....pg. 4 |
| 12-901165-00, 2 PLCS SCREW, 8-32 X 1/4, SEM.....pg. 6 | 22-119650-00 TY-WRAP, NYLON, NATURAL, SHORT (MPB) pg. 20 | 67-599272-00, 2 PLCS MTG CLIP, LED,pg. 4 |
| 12-901165-00, 3 PLCS SCREW, 8-32 X 1/4, SEM.....pg. 4 | 22-119785-00 CLAMP, CABLE 1/8..... pg. 14 | R0-028000-55, 2 PLCS STANDOFF, 4-40 THRU X .25L X 3/16 HEX.....pg. 6 |
| 12-901165-00, 6 PLCS SCREW, 8-32 X 1/4, SEMSpg. 14 | 22-119785-00 CLAMP, CABLE 1/8" pg. 12 | R0-028000-84 FOOT, MOUNTINGpg. 2 |
| 12-901165-00, 6 PLCS SCREW, 8-32 X 1/4", SEM.....pg. 10 | 22-119918-00 CLAMP, 5/16 ALUM pg. 14 | R0-028120-23 WASHER, #10, FLATpg. 2 |
| 12-901165-00, 8 PLCS SCREW, 8-32 X 1/4, SEM.....pg. 8 | 22-120322-00, 2 PLCS CLAMP, CABLE, STANDOFF pg. 18 | |
| 12-902733-00, 4 PLCS SCREW, 8-32 X 5/16, TRUSSpg. 6 | 22-300001-00, 3 PLCS STANDOFF, CABLE CLAMP pg. 18 | |
| 12-902733-00, 8 PLCS SCREW, 8-32 X 5/16, TRUSSpg. 23 | 24-799873-00, 2 PLCS BUSHING, NYLON, SNAP, BLACK 5/8 pg. 4 | |
| 13-312008-00, 2 PLCS NUT, KEPS, #8.....pg. 8 | 24-799873-00 BUSHING, NYLON, SNAP, BLACK 5/8 pg. 16 | |
| 14-122010-00, 4 PLCS WASHER, #10, FLATpg. 8 | | |

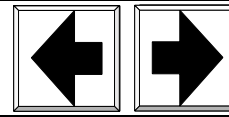

| | |
|--|---|
| 03-917142-00 VITON FERRULE DISC. USE -50.....pg. 4 | 12-901163-00, 4 PLCS SCR, SEM, 8-32 X 3/8..... pg. 2 |
| 03-917145-01 TUBING CONN. 1/16 12IN.....pg. 4 | 12-901165-00, 2 PLCS SCREW, SEM, 8-32 X 1/4..... pg. 2 |
| 03-917157-00 WASHER FERRULE, HOLD USE -50pg. 4 | 12-901165-00, 2 PLCS SCREW, SEM, 8-32 X 1/4..... pg. 2 |
| 03-918164-03 CARRIER GAS ID (GREEN).....pg. 4 | 12-901165-00, 2 PLCS SCREW, SEM, 8-32 X 1/4..... pg. 4 |
| 03-925377-01 3800 PNEUMATICS MANIFOLDpg. 2 | 12-902733-00, 14 PLCS SCREW, 8-32 X 5/16, SS..... pg. 8 |
| 03-925457-02 SOLENOID, 3900 POWER FAIL.....pg. 5 | 14-901030-00, 2 PLCS (REF.) WASHER, FLAT, #10, STT pg. 5 |
| 03-925467-03 SOLENOID 3900 POWER FAIL.....pg. 4 | 28-691944-00 1/8 X 1/8 X 1/8IN TEE-BRASS pg. 2 |
| 03-933172-01 COVER, LEFT SIDE SERVICE.....pg. 8 | 28-693973-00 UNION, BLKHD, 1/8 X 1/8..... pg. 2 |
| 03-933173-01 COVER, OVEN, LEFT SIDEpg. 8 | 28-849067-00, 3 PLCS ADAPT, HOSE, 10-32 pg. 4 |
| 03-933194-01 BRACKET, MANIFOLD.....pg. 2 | 28-849067-00, 3 PLCS FITTING, HOSE ADAPTER..... pg. 5 |
| 03-933201-01 LABEL, MAX PRESS, CARRIER GAS.....pg. 8 | 28-849071-00 FITTING HOSE ADAPTER, ELBOW, 10-32 pg. 5 |
| 03-933204-01 LABEL, S/N TAG, MODEL 3900pg. 8 | 28-849969-00 ADAPTER, HOSE, ELBOW..... pg. 4 |
| 03-933508-01 ASSY, CABLE, EFC, 3900GC.....pg. 2 | 37-000820-15 1/8" DIAMETER COPPER TUBING, 4.5" pg. 2 |
| 12-901161-02, 2 PLCS (REF.) SCREW, SEMS, 6-32 X 3.8, SSTpg. 5 | 57-000028-00 VALVE, NUPRO B-2SA..... pg. 4 |

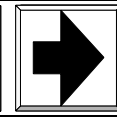
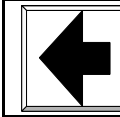

03-933013-01
ASSY, INJECTOR COVERpg. 2

03-933161-01
COVER, INJECTOR.....pg. 2

03-933193-01, 4 PLCS
ROLLER, INJECTOR COVERpg. 2

03-933195-01
CAPpg. 2

03-933198-01
SHIPPING PINpg. 2

12-901163-00, 4 PLCS
SCREW, 8-32 X 3/8, SEMSpg. 2

12-902733-00, 4 PLCS
SCREW, 8-32 X 5/16, TRUSS, SS.....pg. 2

14-901074-00, 4 PLCS
WASHER, FLAT, #6pg. 2

22-119650-00
TIE WRAP SHORT.....pg. 2

23-620785-00, 4 PLCS
FASTENER, BALL STUD.....pg. 2

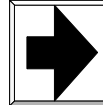
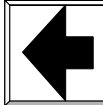

03-917142-00, 3 PLCS
FERRULE, VITON 2
03-917143-00
PIN, BLANK-OFF 2
03-917145-01
TUBING, 1/16OD X .030ID X 1/2" LG, SST 2
03-917157-00, 3 PLCS
WASHER, FERRULE, VITON 2
03-925457-02
VALVE, SOLENOID, 3-WAY, W/2 PIN CONN 2
12-901161-02, 2 PLCS
SCREW, SEMS, 6-32 X 3.8, SST 2
14-901030-00, 2 PLCS
WASHER, FLAT, #10, STT 2
28-849067-00, 3 PLCS
FITTING, HOSE ADAPTER 2
28-849071-00
FITTING HOSE ADAPTER, ELBOW, 10-32 2

VARIAN



**ALL PART NAMES / PART NUMBERS
(IN NUMERICAL ORDER)**

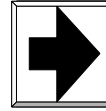
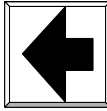

P/N: XX-XXXXXX-XX

DESC: Template

PAGE: 1 of 1

REV
1

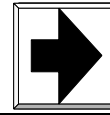
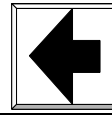

03-933005-01
HEATER COL. OVEN, 1000W, 120V AC.....pg. 3

03-933005-02
HEATER COL. OVEN, 1000W, 230V AC.....pg. 3

03-933005-03
HEATER COL. OVEN, 1000W, 101V AC.....pg. 3

03-933150-01
BAFFLE, INNER OVEN.....pg. 3

03-933506-01
HARNESS, COL OVEN HEATERpg. 3

12-222006-03, 6 PLCS
SCREW, 6-32 X 3/16" LG, PHMS, SSTpg. 3

12-222006-06, 2 PLCS
SCREW, 6-32 X 3/8" LG, PHMS, SSTpg. 3

13-312006-00, 2 PLCS
NUT, KEPS, 6-32pg. 3

14-122006-00, 2 PLCS
WASHER, FLAT, #6pg. 3

14-202006-00, 4 PLCS
WASHER, SPLIT LOCK, #6pg. 3

24-811803-00, 4 PLCS
STANDOFF, 6-32, 3/8OD X .50LGpg. 3

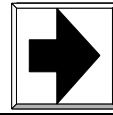
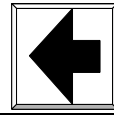

| | |
|--|-------|
| 03-925307-01 ASSY, MOTOR, COL., FAN, 120V..... | pg. 2 |
| 03-925307-02 ASSY, MOTOR, COL., FAN, 230V..... | pg. 2 |
| 03-925307-03 ASSY, MOTOR, COL., FAN, 101V..... | pg. 2 |
| 03-933177-01, 2 PLCS BRACKET, MOTOR MOUNT | pg. 2 |
| 03-933186-01, 3 PLCS VIBRATION ISOLATOR (RECT)..... | pg. 2 |
| 03-933199-01 SHIPPING BRACKET | pg. 2 |
| 12-901135-00, 4 PLCS SCREW, 6-32 X .25, SEMS, STL, NI PL..... | pg. 2 |
| 13-312060-00, 2 PLCS NUT, KEPS, 10-32, SST | pg. 2 |
| 51-406932-00 CONN. HOUSING, 3 CONTACT..... | pg. 2 |

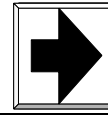
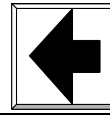

03-933011-01
ASSY, COLUMN OVEN DOORpg. 2

03-933156-01
DOOR, FRONT , GCpg. 2

03-933157-00
STRIKE PLATEpg. 2

03-933159-01
LATCH RELEASEpg. 2

03-933160-01, 2 PLCS
SPRING, OVEN DOOR.....pg. 2

03-933186-03
VIBRATION ISOLATOR (OBROUND)pg. 2

12-901165-00, 4 PLCS
SCREW, 8-32 X 1/4 SEMS, SSTpg. 2

14-999408-00, 2 PLCS
WASHER, FLAT .093ID X .312 X .01, TEFLON pg. 2

17-699907-00, 4 PLCS
RIVET, BLIND, DIA. 1/8 X .265, AL.....pg. 2

19-224776-00, 2 PLCS
ROLL PIN, .094OD X .38 LG.....pg. 2

21-139978-00, 2 PLCS
BEARING, NYLON SLEEVE,
SNAP IN, 1/8" SHAFTpg. 2

71-300053-00
SENSOR, MAGNETIC PROXIMITY,
ACTUATOR.....pg. 2

R0-028000-55, 2 PLCS
STANDOFF, 4-40 X 1/4", HEXpg. 2

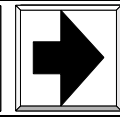
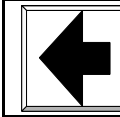

03-925565-01
FLEX COUPLING.....pg. 2

03-933152-01
SHAFT, VENT DOORpg. 2

03-933153-01, 2 PLCS
ARM, VENT DOORpg. 2

03-933154-01, 2 PLCS
DOOR, VENTpg. 2

03-933155-01, 2 PLCS
INSULATION, VENT DOOR.....pg. 2

14-901074-00, 2 PLCS
WASHER, FLAT, #6, .16ID X .87OD.....pg. 2

17-699907-00, 4 PLCS
RIVET, BLIND, ý.125 X .265, SST/STL.....pg. 2

17-699938-00, 2 PLCS
RIVET, BLIND, ý.125 X .390, SST/STL.....pg. 2

17-699938-00, 4 PLCS
RIVET, BLIND, ý.125 X .390, SST/STL.....pg. 2

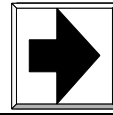
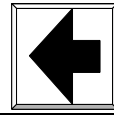

03-910873-01
COMPUTER, PROGRAMMED, 3900 MBpg. 2

03-925305-01
ASSY, CHASSIS FANpg. 2

03-933171-01
COVER, RIGHT SIDE SERVICEpg. 2

03-933350-01
ASSY, PWA, MAIN BOARDpg. 2

12-222006-04, 8 PLCS
SCREW, 6-32 X 1/4" LG, PHMS, SSTpg. 2

12-222008-23, 4 PLCS
SCREW, 8-32 X 1-3/8" LG, PHMS, SSTpg. 2

13-312008-00, 4 PLCS
KEP NUT, EXT TH LOCK, 8-32pg. 2

14-901074-00
WASHER, .16ID X .87OD X .03 THK, SSTpg. 2

20-839825-00
FINGER GUARD, FANpg. 2

51-959920-00, 4 PLCS
FEMALE SCREW LOCK SET, 4-40 X .31pg. 3